



















## Replacement parts suitable for TRUMPF®

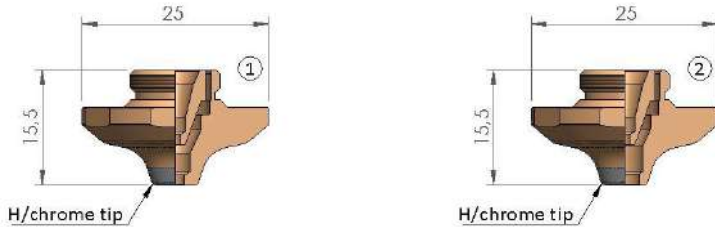

POS		ORIGINAL CODE	DESCRIPTION	unit price	10 pack price
1	014065CK	1579549	TRUMPF® DOUBLE NOZZLE EAK Ø 2.5 CP		
	014066CK	1579556	TRUMPF® DOUBLE NOZZLE EAK Ø 3.0 CP		
2	014067CK	1835747	TRUMPF® DOUBLE NOZZLE EAK Ø 4.0 CP		

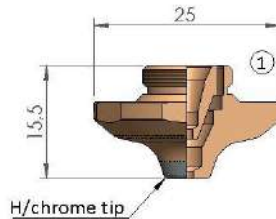

POS		ORIGINAL CODE	DESCRIPTION	unit price	10 pack price
1	014075CK	1664569	TRUMPF® DOUBLE NOZZLE EAN Ø 1.7 CP		
	014076CK	1664602	TRUMPF® DOUBLE NOZZLE EAN Ø 2.0 CP		
	014077CK	1664625	TRUMPF® DOUBLE NOZZLE EAN Ø 2.5 CP		

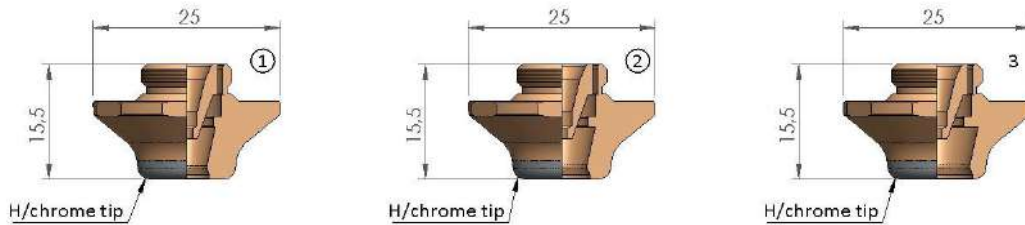

POS		ORIGINAL CODE	DESCRIPTION	unit price	10 pack price
1	014082CK	1809091	TRUMPF® DOUBLE NOZZLE EAQ Ø 6.0 CP		
2	014083CK	1809421	TRUMPF® DOUBLE NOZZLE EAQ Ø 7.5 CP		
3	014084CK	1886199	TRUMPF® DOUBLE NOZZLE EAQ Ø 9.5 CP		

San Giorgio Plasma Parts srls is not affiliated with the named manufacturers. Reference to machines, parts, descriptions, and model numbers are for convenience in verifying compatibility only. All parts are made by or for San Giorgio Plasma Parts srls and are not made by the reference manufactures (unless expressly indicated). All other trademarks are the properties of their respective owners."

## Replacement parts suitable for TRUMPF®



POS	CODE	ORIGINAL CODE	DESCRIPTION	unit price	10 pack price
1	014050	1851641	TRUMPF® NOZZLE ECP Ø 0,8		
	014050W	1851641	TRUMPF® NOZZLE ECP Ø 0,8		
	014051	1851587	TRUMPF® NOZZLE ECP Ø 1.0		
	014051W	1851587	TRUMPF® NOZZLE ECP Ø 1.0		
	014052	1851588	TRUMPF® NOZZLE ECP Ø 1.2		
	014052W	1851588	TRUMPF® NOZZLE ECP Ø 1.2		
	014053	1851618	TRUMPF® NOZZLE ECP Ø 1.4		
	014053W	1851618	TRUMPF® NOZZLE ECP Ø 1.4		
	014054	1851619	TRUMPF® NOZZLE ECP Ø 1.7		
	014054W	1851619	TRUMPF® NOZZLE ECP Ø 1.7		
	014055	1851620	TRUMPF® NOZZLE ECP Ø 2.0		
	014055W	1851620	TRUMPF® NOZZLE ECP Ø 2.0		
	014056	1851651	TRUMPF® NOZZLE ECP Ø 2.3		
	014056W	1851651	TRUMPF® NOZZLE ECP Ø 2.3		
2	014057	1851652	TRUMPF® NOZZLE ECP Ø 2.7		
	014057W	1851652	TRUMPF® NOZZLE ECP Ø 2.7		
	014050CK	1851641	TRUMPF® NOZZLE ECP Ø 0,8 CP		
	014050CKW	1851641	TRUMPF® NOZZLE ECP Ø 0,8 CP		
	014051CK	1851587	TRUMPF® NOZZLE ECP Ø 1.0 CP		
	014051CKW	1851587	TRUMPF® NOZZLE ECP Ø 1.0 CP		
	014052CK	1851588	TRUMPF® NOZZLE ECP Ø 1.2 CP		
	014052CKW	1851588	TRUMPF® NOZZLE ECP Ø 1.2 CP		
	014053CK	1851618	TRUMPF® NOZZLE ECP Ø 1.4 CP		
	014053CKW	1851618	TRUMPF® NOZZLE ECP Ø 1.4 CP		
	014054CK	1851619	TRUMPF® NOZZLE ECP Ø 1.7 CP		
	014054CKW	1851619	TRUMPF® NOZZLE ECP Ø 1.7 CP		
	014055CK	1851620	TRUMPF® NOZZLE ECP Ø 2.0 CP		
	014055CKW	1851620	TRUMPF® NOZZLE ECP Ø 2.0 CP		
014056CK	1851651	TRUMPF® NOZZLE ECP Ø 2.3 CP			
014056CKW	1851651	TRUMPF® NOZZLE ECP Ø 2.3 CP			
014057CK	1851652	TRUMPF® NOZZLE ECP Ø 2.7 CP			
014057CKW	1851652	TRUMPF® NOZZLE ECP Ø 2.7 CP			

San Giorgio Plasma Parts srls is not affiliated with the named manufacturers. Reference to machines, parts, descriptions, and model numbers are for convenience in verifying compatibility only. All parts are made by or for San Giorgio Plasma Parts srls and are not made by the reference manufacturers (unless expressly indicated). All other trademarks are the properties of their respective owners."

## Replacement parts suitable for TRUMPF®

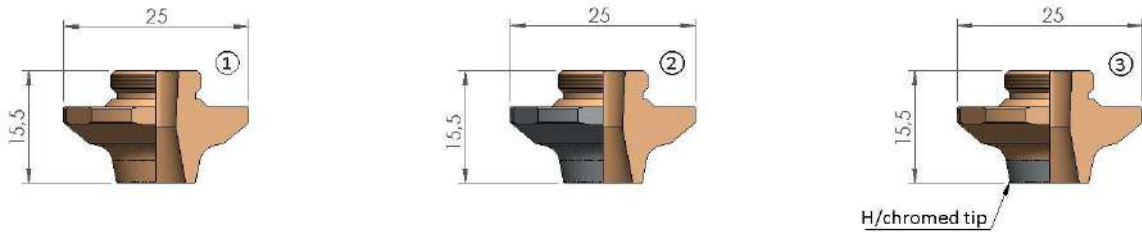

POS	CODE	ORIGINAL CODE	DESCRIPTION	unit price	10 pack price
1	014060	1633046	TRUMPF® NOZZLE EAC Ø 5.3		
	014060W	1633046	TRUMPF® NOZZLE EAC Ø 5.3		
2	014060C	1633046	TRUMPF® NOZZLE EAC Ø 5.3 CP		
	014060CW	1633046	TRUMPF® NOZZLE EAC Ø 5.3 CP		
3	014060CK	1633046	TRUMPF® NOZZLE EAC Ø 5.3 CP		
	014060CKW	1633046	TRUMPF® NOZZLE EAC Ø 5.3 CP		

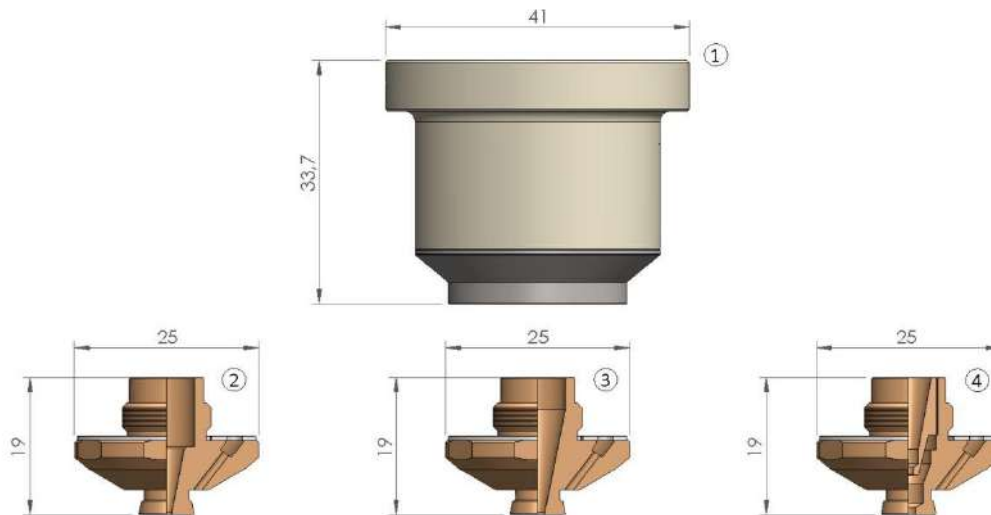

POS	CODE	ORIGINAL CODE	DESCRIPTION	unit price	10 pack price
1	019007	1906032	TRUMPF® NOZZLE HOLDER COOL LINE M12		
2	014020	1879940	TRUMPF® NOZZLE EGL Ø 1.4		
	014021	1879951	TRUMPF® NOZZLE EGL Ø 1.7		
3	014022	1879952	TRUMPF® NOZZLE EGL Ø 2.0		
	014023	1879953	TRUMPF® NOZZLE EGL Ø 2.3		
4	014030		TRUMPF® DOUBLE NOZZLE EGL Ø 2.0		
	014031		TRUMPF® DOUBLE NOZZLE EGL Ø 2.5		
	014032		TRUMPF® DOUBLE NOZZLE EGL Ø 3.0		
	014033		TRUMPF® DOUBLE NOZZLE EGL Ø 4.0		

San Giorgio Plasma Parts srls is not affiliated with the named manufacturers. Reference to machines, parts, descriptions, and model numbers are for convenience in verifying compatibility only. All parts are made by or for San Giorgio Plasma Parts srls and are not made by the reference manufactures (unless expressly indicated). All other trademarks are the properties of their respective owners."

## Replacement parts suitable for TRUMPF®

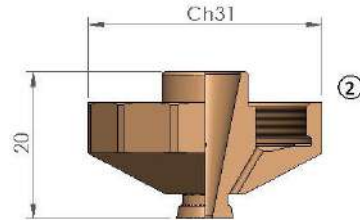
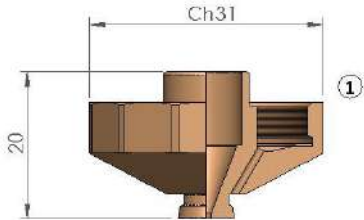

POS	CODE	ORIGINAL CODE	DESCRIPTION	unit price	10 pack price
1	015001	1774018	TRUMPF® NOZZLE EFL Ø 1.4		
	015002	1838745	TRUMPF® NOZZLE EFL Ø 1.7		
2	015003	1774020	TRUMPF® NOZZLE EFL Ø 2.0		
	015004	1774092	TRUMPF® NOZZLE EFL Ø 2.3		

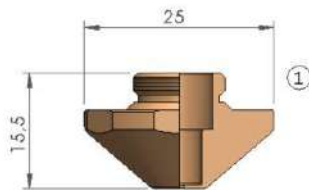

POS	CODE	ORIGINAL CODE	DESCRIPTION	unit price	10 pack price
1	014061	1637264	TRUMPF® NOZZLE ZAA-01		
	014061W	1637264	TRUMPF® NOZZLE Ø 1.4 ZAA-01		

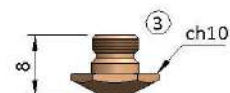
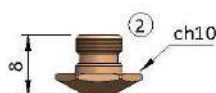
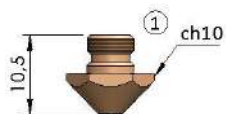

POS	CODE	ORIGINAL CODE	DESCRIPTION	unit price	10 pack price
1	013074	1384753	TRUMPF® NOZZLE Ø 2.0 BLOW OFF EBM		
2	013071	1736458	TRUMPF® NOZZLE Ø 1.0 BLOW OFF EBM		
3	013073	1589610	TRUMPF® NOZZLE Ø 2.0 BLOW OFF EBM		

San Giorgio Plasma Parts srls is not affiliated with the named manufacturers. Reference to machines, parts, descriptions, and model numbers are for convenience in verifying compatibility only. All parts are made by or for San Giorgio Plasma Parts srls and are not made by the reference manufactures (unless expressly indicated). All other trademarks are the properties of their respective owners."

## Replacement parts suitable for TRUMPF®

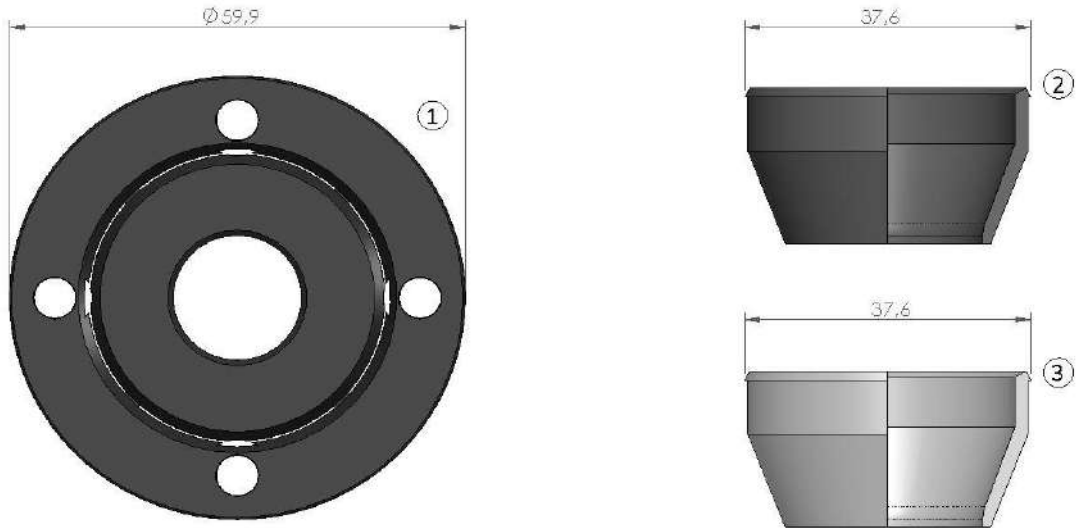

POS	CODE	ORIGINAL CODE	DESCRIPTION	unit price	10 pack price
1	019020	234485	TRUMPF® BREAK-AWAY		
2	019011	256153-955826	TRUMPF® COVER - BLACK		
3	019010	256153-955826	TRUMPF® PTFE COVER - WHITE		

POS	CODE	ORIGINAL CODE	DESCRIPTION	unit price	10 pack price
	019027	245288	TRUMPF® SENSOR CABLE		
	019029	227833	TRUMPF® SENSOR CABLE 430MM BNC		

POS	CODE	ORIGINAL CODE	DESCRIPTION	unit price	10 pack price
	CP10	146152	TRUMPF® ORIGINAL WATER FILTER 30X68X250		
	CP 10	146152	TRUMPF® COMPATIBLE WATER FILTER 30X68X250		

San Giorgio Plasma Parts srls is not affiliated with the named manufacturers. Reference to machines, parts, descriptions, and model numbers are for convenience in verifying compatibility only. All parts are made by or for San Giorgio Plasma Parts srls and are not made by the reference manufacturers (unless expressly indicated). All other trademarks are the properties of their respective owners."

## Replacement parts suitable for TRUMPF®

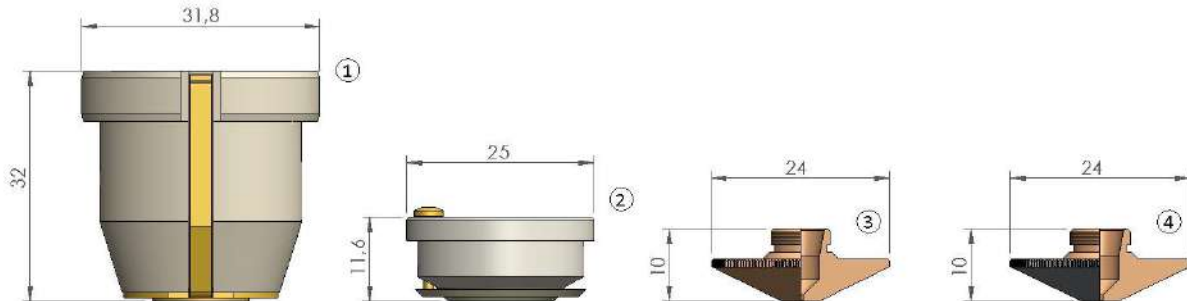

POS	CODE	ORIGINAL CODE	DESCRIPTION	unit price	10 pack price
1	019002	254493-260432	TRUMPF® CERAMIC NOZZLE HOLDER		
2	019001	258809-243839-247894	TRUMPF® CERAMIC NOZZLE HOLDER		
	019009	258809	TRUMPF® ORIGINAL CERAMIC NOZZLE HOLDER		
3	012001W	124561-237499	TRUMPF® NOZZLE Ø 0.8		
	012002W	124562-237498	TRUMPF® NOZZLE Ø 1.0		
	012003W	966809	TRUMPF® NOZZLE Ø 1.2		
	012004W		TRUMPF® NOZZLE Ø 1.4		
	012005W	237500	TRUMPF® NOZZLE Ø 1.5		
	012006W		TRUMPF® NOZZLE Ø 1.7		
	012007W	237503-1253211	TRUMPF® NOZZLE Ø 2.0		
	012008W	237503	TRUMPF® NOZZLE Ø 2.3		
	012009W	237504	TRUMPF® NOZZLE Ø 3.0		
4	012001CW	352280	TRUMPF® NOZZLE Ø 0.8 CP		
	012002CW	352281	TRUMPF® NOZZLE Ø 1.0 CP		
	012003CW	352282	TRUMPF® NOZZLE Ø 1.2 CP		
	012004CW		TRUMPF® NOZZLE Ø 1.4 CP		
	012005CW	352288	TRUMPF® NOZZLE Ø 1.5 CP		
	012006CW		TRUMPF® NOZZLE Ø 1.7 CP		
	012007CW		TRUMPF® NOZZLE Ø 2.0 CP		
	012008CW	124564	TRUMPF® NOZZLE Ø 2.3 CP		
	012009CW		TRUMPF® NOZZLE Ø 3.0 CP		



POS	CODE	ORIGINAL CODE	DESCRIPTION	unit price	10 pack price
1	012017W	237497	TRUMPF® NOZZLE Ø 1.4 HD		
2	012017CW	352283	TRUMPF® NOZZLE Ø 1.4 HD CP		

San Giorgio Plasma Parts srls is not affiliated with the named manufacturers. Reference to machines, parts, descriptions, and model numbers are for convenience in verifying compatibility only. All parts are made by or for San Giorgio Plasma Parts srls and are not made by the reference manufactures (unless expressly indicated). All other trademarks are the properties of their respective owners."

## Replacement parts suitable for TRUMPF®



POS	CODE	ORIGINAL CODE	DESCRIPTION	unit price	10 pack price
1	012018W	237497/s	TRUMPF® NOZZLE Ø 1.4 HD		
	012019W	237501	TRUMPF® NOZZLE Ø 1.7 HD		
	012020W	237502	TRUMPF® NOZZLE Ø 2.0 HD		
	012021W	126933	TRUMPF® NOZZLE Ø 2.3 HD		
	012022W		TRUMPF® NOZZLE Ø 2.5 HD		
	012023W	942742	TRUMPF® NOZZLE Ø 2.7 HD		
	012024W		TRUMPF® NOZZLE Ø 3.0 HD		
2	012018CW		TRUMPF® NOZZLE Ø 1.4 HD CP		
	012019CW	352284	TRUMPF® NOZZLE Ø 1.7 HD CP		
	012020CW	237502	TRUMPF® NOZZLE Ø 2.0 HD CP		
	012021CW	352285	TRUMPF® NOZZLE Ø 2.3 HD CP		
	012022CW		TRUMPF® NOZZLE Ø 2.5 HD CP		
	012023CW	352286	TRUMPF® NOZZLE Ø 2.7 HD CP		
	012024CW		TRUMPF® NOZZLE Ø 3.0 HD CP		



POS	CODE	ORIGINAL CODE	DESCRIPTION	unit price	10 pack price
1	012011W	215780	TRUMPF® NOZZLE Ø 0.8		€ 9.50
	012012W	87658	TRUMPF® NOZZLE Ø 1.0		€ 9.50
2	012011CW		TRUMPF® NOZZLE Ø 0.8 CP		€ 13.00
	012012CW		TRUMPF® NOZZLE Ø 1.0 CP		€ 13.00



POS	CODE	ORIGINAL CODE	DESCRIPTION	unit price	10 pack price
1	012026W	88894	TRUMPF® NOZZLE Ø 1.4 HD		
	012027W	217867	TRUMPF® NOZZLE Ø 1.7 HD		
2	012026CW	88894	TRUMPF® NOZZLE Ø 1.4 HD CP		
	012027CW	217867	TRUMPF® NOZZLE Ø 1.7 HD CP		

## Replacement parts suitable for TRUMPF®

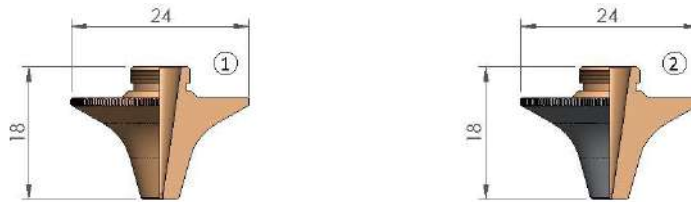

POS	CODE	ORIGINAL CODE	DESCRIPTION	unit price	10 pack price
1	012030	1277773	TRUMPF® NOZZLE Ø 0.8		
	012030W	1277773	TRUMPF® NOZZLE Ø 0.8		
	012031	1277771	TRUMPF® NOZZLE Ø 1.0		
	012031W	1277771	TRUMPF® NOZZLE Ø 1.0		
	012032	1277774	TRUMPF® NOZZLE Ø 1.2		
	012032W	1277774	TRUMPF® NOZZLE Ø 1.2		
	012033	1277776	TRUMPF® NOZZLE Ø 1.4		
	012033W	1277776	TRUMPF® NOZZLE Ø 1.4		
	012034	1277779	TRUMPF® NOZZLE Ø 1.7		
	012034W	1277779	TRUMPF® NOZZLE Ø 1.7		
	012035	1277780	TRUMPF® NOZZLE Ø 2.0		
	012035W	1277780	TRUMPF® NOZZLE Ø 2.0		
	012036	1277781	TRUMPF® NOZZLE Ø 2.3		
	012036W	1277781	TRUMPF® NOZZLE Ø 2.3		
	012037	1277782	TRUMPF® NOZZLE Ø 2.7		
	012037W	1277782	TRUMPF® NOZZLE Ø 2.7		
2	012030C		TRUMPF® NOZZLE Ø 0.8 CP		
	012030CW		TRUMPF® NOZZLE Ø 0.8 CP		
	012031C		TRUMPF® NOZZLE Ø 1.0 CP		
	012031CW		TRUMPF® NOZZLE Ø 1.0 CP		
	012032C		TRUMPF® NOZZLE Ø 1.2 CP		
	012032CW		TRUMPF® NOZZLE Ø 1.2 CP		
	012033C		TRUMPF® NOZZLE Ø 1.4 CP		
	012033CW		TRUMPF® NOZZLE Ø 1.4 CP		
	012034C		TRUMPF® NOZZLE Ø 1.7 CP		
	012034CW		TRUMPF® NOZZLE Ø 1.7 CP		
	012035C		TRUMPF® NOZZLE Ø 2.0 CP		
	012035CW		TRUMPF® NOZZLE Ø 2.0 CP		
	012036C		TRUMPF® NOZZLE Ø 2.3 CP		
	012036CW		TRUMPF® NOZZLE Ø 2.3 CP		
	012037C		TRUMPF® NOZZLE Ø 2.7 CP		
	012037CW		TRUMPF® NOZZLE Ø 2.7 CP		

San Giorgio Plasma Parts srls is not affiliated with the named manufacturers. Reference to machines, parts, descriptions, and model numbers are for convenience in verifying compatibility only. All parts are made by or for San Giorgio Plasma Parts srls and are not made by the reference manufactures (unless expressly indicated). All other trademarks are the properties of their respective owners."



## Replacement parts suitable for TRUMPF®

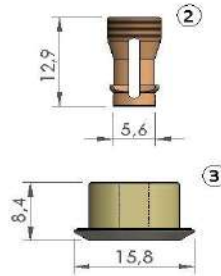
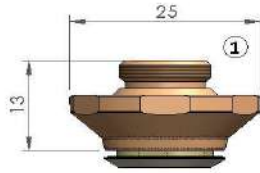

POS	CODE	ORIGINAL CODE	DESCRIPTION	unit price	10 pack price
	014090	2228806	TRUMPF® TOUCHDOWN NOZZLE EAV		
	019022W	2228802	TRUMPF® INNER PART EAV Ø3.0		
	019023W	2284349	TRUMPF® SLEEVE EAV		

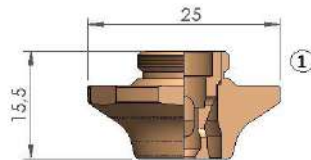

POS	CODE	ORIGINAL CODE	DESCRIPTION	unit price	10 pack price
	014095	2491660	TRUMPF® DOUBLE NOZZLE CAU Ø 10.0		

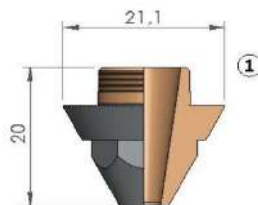

POS	CODE	ORIGINAL CODE	DESCRIPTION	unit price	10 pack price
	016001C	932530	TRUMPF® NOZZLE Ø 4.5 CP		

San Giorgio Plasma Parts srls is not affiliated with the named manufacturers. Reference to machines, parts, descriptions, and model numbers are for convenience in verifying compatibility only. All parts are made by or for San Giorgio Plasma Parts srls and are not made by the reference manufactures (unless expressly indicated). All other trademarks are the properties of their respective owners."