

Replacement parts suitable for PRECITEC®

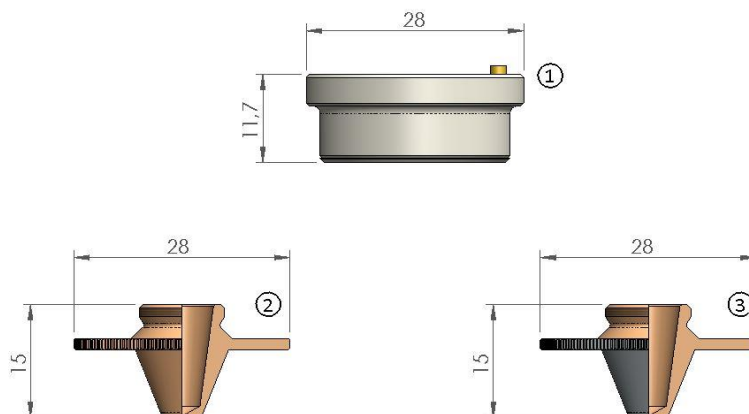

| POS | LS. CODE | ORIGINAL CODE | DESCRIPTION | unit price | 10 pack price |
|----------|----------|--|---|------------|---------------|
| 1 | 059001 | 281330, P0571-260-00001, 6930281330 | PRECITEC® ORIGINAL NOZZLE HOLDER KT B2" | | |
| | 059004 | P0571-260-00001 | PRECITEC® NOZZLE HOLDER KT B2" | | |
| | 059002 | P0571-1051-00001, 6930281333 | PRECITEC® ORIGINAL NOZZLE HOLDER KT B2" CON | | |
| | 059003 | P0571-1051-00001, 6930281333-080800302 | PRECITEC® NOZZLE HOLDER KT B2" CON | | |
| 2 | 051046W | 281590-P0591-569-00008 | PRECITEC® NOZZLE Ø 0.8 | | |
| | 051047W | 281331-P0591-561-00010 | PRECITEC® NOZZLE Ø 1.0 | | |
| | 051048W | 281351-P0591-562-00012 | PRECITEC® NOZZLE Ø 1.2 | | |
| | 051049W | 281352-P0591-563-00015 | PRECITEC® NOZZLE Ø 1.5 | | |
| | 051050W | | PRECITEC® NOZZLE Ø 1.7 | | |
| | 051051W | 281353-P0591-564-00018 | PRECITEC® NOZZLE Ø 1.8 | | |
| | 051052W | 281354-P0591-565-00020 | PRECITEC® NOZZLE Ø 2.0 | | |
| | 051053W | | PRECITEC® NOZZLE Ø 2.3 | | |
| | 051054W | 281591-P0591-566-00025 | PRECITEC® NOZZLE Ø 2.5 | | |
| | 051055W | | PRECITEC® NOZZLE Ø 2.7 | | |
| | 051056W | | PRECITEC® NOZZLE Ø 3.0 | | |
| 3 | 051046CW | 281590-P0591-569-00008 | PRECITEC® NOZZLE Ø 0.8 CP | | |
| | 051047CW | 281331-P0591-561-00010 | PRECITEC® NOZZLE Ø 1.0 CP | | |
| | 051048CW | 281351-P0591-562-00012 | PRECITEC® NOZZLE Ø 1.2 CP | | |
| | 051049CW | 281352-P0591-563-00015 | PRECITEC® NOZZLE Ø 1.5 CP | | |
| | 051050CW | | PRECITEC® NOZZLE Ø 1.7 CP | | |
| | 051051CW | 281353-P0591-564-00018 | PRECITEC® NOZZLE Ø 1.8 CP | | |
| | 051052CW | 281354-P0591-565-00020 | PRECITEC® NOZZLE Ø 2.0 CP | | |
| | 051053CW | | PRECITEC® NOZZLE Ø 2.3 CP | | |
| | 051054CW | 281591-P0591-566-00025 | PRECITEC® NOZZLE Ø 2.5 CP | | |
| | 051055CW | | PRECITEC® NOZZLE Ø 2.7 CP | | |
| 051056CW | | PRECITEC® NOZZLE Ø 3.0 CP | | | |

San Giorgio Plasma Parts srls is not affiliated with the named manufacturers. Reference to machines, parts, descriptions, and model numbers are for convenience in verifying compatibility only. All parts are made by or for San Giorgio Plasma Parts srls and are not made by the reference manufacturers (unless expressly indicated). All other trademarks are the properties of their respective owners."

Replacement parts suitable for PRECITEC®

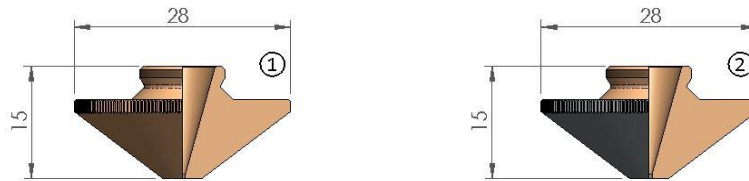

| POS | LS. CODE | ORIGINAL CODE | DESCRIPTION | unit price | 10 pack price |
|----------|----------|---|-------------------------------|------------------------------|---------------|
| 1 | 051002W | | PRECITEC® NOZZLE Ø 0.8 HD | | |
| | 051003W | 281548-P0591-571-00010-29100233 | PRECITEC® NOZZLE Ø 1.0 HD | | |
| | 051004W | 281549-P0591-572-00012-29100234 | PRECITEC® NOZZLE Ø 1.2 HD | | |
| | 051005W | | PRECITEC® NOZZLE Ø 1.4 HD | | |
| | 051006W | P0591-573-00015-281463-29100235-080800230 | PRECITEC® NOZZLE Ø 1.5 HD | | |
| | 051007W | P0591-574-00018-29100236 | PRECITEC® NOZZLE Ø 1.8 HD | | |
| | 051008W | 10.03.11.09.011-281550-P0591-575-00020-29100237-080800231 | PRECITEC® NOZZLE Ø 2.0 HD | | |
| | 051009W | | PRECITEC® NOZZLE Ø 2.3 HD | | |
| | 051010W | 10.03.11.09.012-281551-P0591-576-00025-29100239-080800232 | PRECITEC® NOZZLE Ø 2.5 HD | | |
| | 051011W | | PRECITEC® NOZZLE Ø 2.75 HD | | |
| | 051012W | P0591-577-00030 | PRECITEC® NOZZLE Ø 3.0 HD | | |
| | 051013W | | PRECITEC® NOZZLE Ø 3.2 HD | | |
| | 051014W | 10.03.11.09.014-29100243-08 | PRECITEC® NOZZLE Ø 3.5 HD | | |
| | 051015W | | PRECITEC® NOZZLE Ø 4.0 HD | | |
| | 051016W | | PRECITEC® NOZZLE Ø 4.5 HD | | |
| | 051017W | | PRECITEC® NOZZLE Ø 5.0 HD | | |
| | 2 | 051002CW | | PRECITEC® NOZZLE Ø 0.8 HD CP | |
| 051003CW | | 281548-P0591-571-00010 | PRECITEC® NOZZLE Ø 1.0 HD CP | | |
| 051004CW | | 281549-P0591-572-00012 | PRECITEC® NOZZLE Ø 1.2 HD CP | | |
| 051005CW | | | PRECITEC® NOZZLE Ø 1.4 HD CP | | |
| 051006CW | | 281463-P0591-573-00015 | PRECITEC® NOZZLE Ø 1.5 HD CP | | |
| 051007CW | | P0591-574-00018 | PRECITEC® NOZZLE Ø 1.8 HD CP | | |
| 051008CW | | 281550-P0591-575-00020 | PRECITEC® NOZZLE Ø 2.0 HD CP | | |
| 051009CW | | | PRECITEC® NOZZLE Ø 2.3 HD CP | | |
| 051010CW | | 281551-P0591-576-00025 | PRECITEC® NOZZLE Ø 2.5 HD CP | | |
| 051011CW | | | PRECITEC® NOZZLE Ø 2.75 HD CP | | |
| 051012CW | | | PRECITEC® NOZZLE Ø 3.0 HD CP | | |
| 051013CW | | | PRECITEC® NOZZLE Ø 3.2 HD CP | | |
| 051014CW | | | PRECITEC® NOZZLE Ø 3.5 HD CP | | |
| 051015CW | | | PRECITEC® NOZZLE Ø 4.0 HD CP | | |
| 051016CW | | | PRECITEC® NOZZLE Ø 4.5 HD CP | | |
| 051017CW | | | PRECITEC® NOZZLE Ø 5.0 HD CP | | |

San Giorgio Plasma Parts srls is not affiliated with the named manufacturers. Reference to machines, parts, descriptions, and model numbers are for convenience in verifying compatibility only. All parts are made by or for San Giorgio Plasma Parts srls and are not made by the reference manufactures (unless expressly indicated). All other trademarks are the properties of their respective owners."

Replacement parts suitable for PRECITEC®

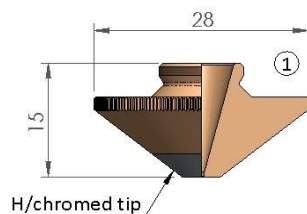

| POS | LS. CODE | ORIGINAL CODE | DESCRIPTION | unit price | 10 pack price |
|-----|-----------|---------------|-------------------------------|------------|---------------|
| 1 | 051002CK | | PRECITEC® NOZZLE Ø 0.8 HD CP | | |
| | 051002CKW | | PRECITEC® NOZZLE Ø 0.8 HD CP | | |
| | 051003CK | | PRECITEC® NOZZLE Ø 1.0 HD CP | | |
| | 051003CKW | | PRECITEC® NOZZLE Ø 1.0 HD CP | | |
| | 051004CK | | PRECITEC® NOZZLE Ø 1.2 HD CP | | |
| | 051004CKW | | PRECITEC® NOZZLE Ø 1.2 HD CP | | |
| | 051005CK | | PRECITEC® NOZZLE Ø 1.4 HD CP | | |
| | 051005CKW | | PRECITEC® NOZZLE Ø 1.4 HD CP | | |
| | 051006CK | | PRECITEC® NOZZLE Ø 1.5 HD CP | | |
| | 051006CKW | | PRECITEC® NOZZLE Ø 1.5 HD CP | | |
| | 051007CK | | PRECITEC® NOZZLE Ø 1.8 HD CP | | |
| | 051007CKW | | PRECITEC® NOZZLE Ø 1.8 HD CP | | |
| | 051008CK | | PRECITEC® NOZZLE Ø 2.0 HD CP | | |
| | 051008CKW | | PRECITEC® NOZZLE Ø 2.0 HD CP | | |
| | 051009CK | | PRECITEC® NOZZLE Ø 2.3 HD CP | | |
| | 051009CKW | | PRECITEC® NOZZLE Ø 2.3 HD CP | | |
| | 051010CK | | PRECITEC® NOZZLE Ø 2.5 HD CP | | |
| | 051010CKW | | PRECITEC® NOZZLE Ø 2.5 HD CP | | |
| | 051011CK | | PRECITEC® NOZZLE Ø 2.75 HD CP | | |
| | 051011CKW | | PRECITEC® NOZZLE Ø 2.75 HD CP | | |
| | 051012CK | | PRECITEC® NOZZLE Ø 3.0 HD CP | | |
| | 051012CKW | | PRECITEC® NOZZLE Ø 3.0 HD CP | | |
| | 051013CK | | PRECITEC® NOZZLE Ø 3.2 HD CP | | |
| | 051013CKW | | PRECITEC® NOZZLE Ø 3.2 HD CP | | |
| | 051014CK | | PRECITEC® NOZZLE Ø 3.5 HD CP | | |
| | 051014CKW | | PRECITEC® NOZZLE Ø 3.5 HD CP | | |
| | 051015CK | | PRECITEC® NOZZLE Ø 4.0 HD CP | | |
| | 051015CKW | | PRECITEC® NOZZLE Ø 4.0 HD CP | | |
| | 051016CK | | PRECITEC® NOZZLE Ø 4.5 HD CP | | |
| | 051016CKW | | PRECITEC® NOZZLE Ø 4.5 HD CP | | |
| | 051017CK | | PRECITEC® NOZZLE Ø 5.0 HD CP | | |
| | 051017CKW | | PRECITEC® NOZZLE Ø 5.0 HD CP | | |

San Giorgio Plasma Parts srls is not affiliated with the named manufacturers. Reference to machines, parts, descriptions, and model numbers are for convenience in verifying compatibility only. All parts are made by or for San Giorgio Plasma Parts srls and are not made by the reference manufacturers (unless expressly indicated). All other trademarks are the properties of their respective owners."

Replacement parts suitable for PRECITEC®

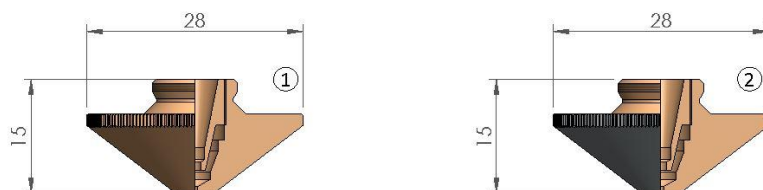

| POS | LS. CODE | ORIGINAL CODE | DESCRIPTION | unit price | 10 pack price |
|----------|---------------------|----------------------------------|----------------------------------|------------|---------------|
| 1 | 051024W | | PRECITEC® DOUBLE NOZZLE Ø 0.8 | | |
| | 051025W | P0591-002-00010 | PRECITEC® DOUBLE NOZZLE Ø 1.0 | | |
| | 051026W | P0591-002-00012 | PRECITEC® DOUBLE NOZZLE Ø 1.2 | | |
| | 051027W | | PRECITEC® DOUBLE NOZZLE Ø 1.4 | | |
| | 051028W | P0591-002-00015 | PRECITEC® DOUBLE NOZZLE Ø 1.5 | | |
| | 051029W | 10.03.11.09.031/P0591-002-00018 | PRECITEC® DOUBLE NOZZLE Ø 1.8 | | |
| | 051030W | P0591-002-00020 | PRECITEC® DOUBLE NOZZLE Ø 2.0 | | |
| | 051031W | P0591-002-00023 | PRECITEC® DOUBLE NOZZLE Ø 2.3 | | |
| | 051032W | P0591-002-00025 | PRECITEC® DOUBLE NOZZLE Ø 2.5 | | |
| | 051038W | | PRECITEC® DOUBLE NOZZLE Ø 2.7 | | |
| | 051033W | P0591-002-00030 | PRECITEC® DOUBLE NOZZLE Ø 3.0 | | |
| | 051034W | P0591-002-00035-29100384 | PRECITEC® DOUBLE NOZZLE Ø 3.5 | | |
| | 051035W | P0591-002-00040 | PRECITEC® DOUBLE NOZZLE Ø 4.0 | | |
| | 051036W | | PRECITEC® DOUBLE NOZZLE Ø 4.5 | | |
| 051037W | 10.03.11.09.029-080 | PRECITEC® DOUBLE NOZZLE Ø 5.0 | | | |
| 2 | 051024CW | | PRECITEC® DOUBLE NOZZLE Ø 0.8 CP | | |
| | 051025CW | | PRECITEC® DOUBLE NOZZLE Ø 1.0 CP | | |
| | 051026CW | | PRECITEC® DOUBLE NOZZLE Ø 1.2 CP | | |
| | 051027CW | | PRECITEC® DOUBLE NOZZLE Ø 1.4 CP | | |
| | 051028CW | | PRECITEC® DOUBLE NOZZLE Ø 1.5 CP | | |
| | 051029CW | | PRECITEC® DOUBLE NOZZLE Ø 1.8 CP | | |
| | 051030CW | | PRECITEC® DOUBLE NOZZLE Ø 2.0 CP | | |
| | 051031CW | | PRECITEC® DOUBLE NOZZLE Ø 2.3 CP | | |
| | 051032CW | | PRECITEC® DOUBLE NOZZLE Ø 2.5 CP | | |
| | 051038CW | | PRECITEC® DOUBLE NOZZLE Ø 2.7 CP | | |
| | 051033CW | | PRECITEC® DOUBLE NOZZLE Ø 3.0 CP | | |
| | 051034CW | | PRECITEC® DOUBLE NOZZLE Ø 3.5 CP | | |
| | 051035CW | | PRECITEC® DOUBLE NOZZLE Ø 4.0 CP | | |
| | 051036CW | | PRECITEC® DOUBLE NOZZLE Ø 4.5 CP | | |
| 051037CW | | PRECITEC® DOUBLE NOZZLE Ø 5.0 CP | | | |

San Giorgio Plasma Parts srls is not affiliated with the named manufacturers. Reference to machines, parts, descriptions, and model numbers are for convenience in verifying compatibility only. All parts are made by or for San Giorgio Plasma Parts srls and are not made by the reference manufacturers (unless expressly indicated). All other trademarks are the properties of their respective owners."

Replacement parts suitable for PRECITEC®

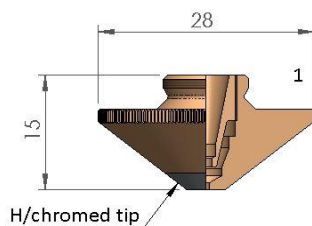

| POS | LS. CODE | ORIGINAL CODE | DESCRIPTION | unit price | 10 pack price |
|-----|-----------|---------------|----------------------------------|------------|---------------|
| 1 | 051024CK | | PRECITEC® DOUBLE NOZZLE Ø 0.8 CP | | |
| | 051024CKW | | PRECITEC® DOUBLE NOZZLE Ø 0.8 CP | | |
| | 051025CK | | PRECITEC® DOUBLE NOZZLE Ø 1.0 CP | | |
| | 051025CKW | | PRECITEC® DOUBLE NOZZLE Ø 1.0 CP | | |
| | 051026CK | | PRECITEC® DOUBLE NOZZLE Ø 1.2 CP | | |
| | 051026CKW | | PRECITEC® DOUBLE NOZZLE Ø 1.2 CP | | |
| | 051027CK | | PRECITEC® DOUBLE NOZZLE Ø 1.4 CP | | |
| | 051027CKW | | PRECITEC® DOUBLE NOZZLE Ø 1.4 CP | | |
| | 051028CK | | PRECITEC® DOUBLE NOZZLE Ø 1.5 CP | | |
| | 051028CKW | | PRECITEC® DOUBLE NOZZLE Ø 1.5 CP | | |
| | 051029CK | | PRECITEC® DOUBLE NOZZLE Ø 1.8 CP | | |
| | 051029CKW | | PRECITEC® DOUBLE NOZZLE Ø 1.8 CP | | |
| | 051030CK | | PRECITEC® DOUBLE NOZZLE Ø 2.0 CP | | |
| | 051030CKW | | PRECITEC® DOUBLE NOZZLE Ø 2.0 CP | | |
| | 051031CK | | PRECITEC® DOUBLE NOZZLE Ø 2.3 CP | | |
| | 051031CKW | | PRECITEC® DOUBLE NOZZLE Ø 2.3 CP | | |
| | 051032CK | | PRECITEC® DOUBLE NOZZLE Ø 2.5 CP | | |
| | 051032CKW | | PRECITEC® DOUBLE NOZZLE Ø 2.5 CP | | |
| | 051038CK | | PRECITEC® DOUBLE NOZZLE Ø 2.7 CP | | |
| | 051038CKW | | PRECITEC® DOUBLE NOZZLE Ø 2.7 CP | | |
| | 051033CK | | PRECITEC® DOUBLE NOZZLE Ø 3.0 CP | | |
| | 051033CKW | | PRECITEC® DOUBLE NOZZLE Ø 3.0 CP | | |
| | 051034CK | | PRECITEC® DOUBLE NOZZLE Ø 3.5 CP | | |
| | 051034CKW | | PRECITEC® DOUBLE NOZZLE Ø 3.5 CP | | |
| | 051035CK | | PRECITEC® DOUBLE NOZZLE Ø 4.0 CP | | |
| | 051035CKW | | PRECITEC® DOUBLE NOZZLE Ø 4.0 CP | | |
| | 051036CK | | PRECITEC® DOUBLE NOZZLE Ø 4.5 CP | | |
| | 051036CKW | | PRECITEC® DOUBLE NOZZLE Ø 4.5 CP | | |
| | 051037CK | | PRECITEC® DOUBLE NOZZLE Ø 5.0 CP | | |
| | 051037CKW | | PRECITEC® DOUBLE NOZZLE Ø 5.0 CP | | |

San Giorgio Plasma Parts srls is not affiliated with the named manufacturers. Reference to machines, parts, descriptions, and model numbers are for convenience in verifying compatibility only. All parts are made by or for San Giorgio Plasma Parts srls and are not made by the reference manufacturers (unless expressly indicated). All other trademarks are the properties of their respective owners."

Replacement parts suitable for PRECITEC®

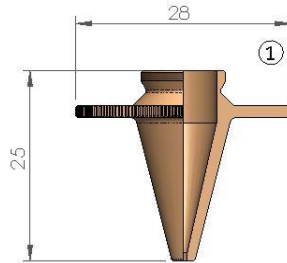

| POS | LS. CODE | ORIGINAL CODE | DESCRIPTION | unit price | 10 pack price |
|-----|----------|---------------|-----------------------------|------------|---------------|
| | 053008 | | PRECITEC® NOZZLE LONG Ø 1.0 | | |
| | 053009 | | PRECITEC® NOZZLE LONG Ø 1.5 | | |
| | 053010 | | PRECITEC® NOZZLE LONG Ø 1.8 | | |
| | 053011 | | PRECITEC® NOZZLE LONG Ø 2.0 | | |

Replacement parts suitable for PRECITEC®

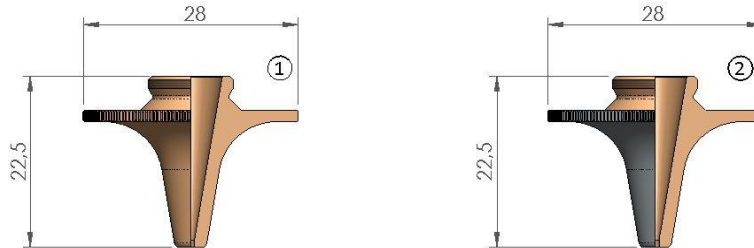

| POS | LS. CODE | ORIGINAL CODE | DESCRIPTION | unit price | 10 pack price |
|-----|----------|-------------------------------|---------------------------------------|------------|---------------|
| 1 | 053002 | P0578-0411-00010 | PRECITEC® NOZZLE RADIUS LONG Ø 1.0 | | |
| | 053003 | P0578-0412-00012 | PRECITEC® NOZZLE RADIUS LONG Ø 1.2 | | |
| | 053004 | P0578-0413-00015 / 6930300039 | PRECITEC® NOZZLE RADIUS LONG Ø 1.5 | | |
| | 053005 | P0578-0414-00018 | PRECITEC® NOZZLE RADIUS LONG Ø 1.8 | | |
| | 053006 | P0578-0415-00020 / 6930300040 | PRECITEC® NOZZLE RADIUS LONG Ø 2.0 | | |
| | 053007 | P0578-0417-00025 | PRECITEC® NOZZLE RADIUS LONG Ø 2.5 | | |
| 2 | 053002C | | PRECITEC® NOZZLE RADIUS LONG Ø 1.0 CP | | |
| | 053003C | | PRECITEC® NOZZLE RADIUS LONG Ø 1.2 CP | | |
| | 053004C | | PRECITEC® NOZZLE RADIUS LONG Ø 1.5 CP | | |
| | 053005C | | PRECITEC® NOZZLE RADIUS LONG Ø 1.8 CP | | |
| | 053006C | | PRECITEC® NOZZLE RADIUS LONG Ø 2.0 CP | | |
| | 053007C | | PRECITEC® NOZZLE RADIUS LONG Ø 2.5 CP | | |

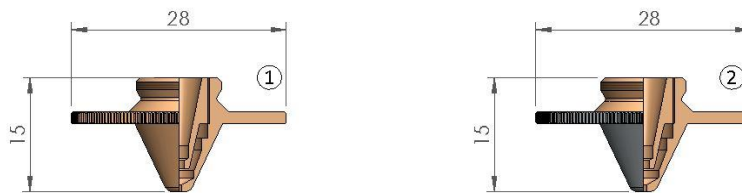

| POS | LS. CODE | ORIGINAL CODE | DESCRIPTION | unit price | 10 pack price |
|-----|----------|---------------|----------------------------------|------------|---------------|
| 1 | 051060W | 6930250001 | PRECITEC® DOUBLE NOZZLE Ø 0.8 | | |
| | 051061W | 6930250002 | PRECITEC® DOUBLE NOZZLE Ø 1.0 | | |
| | 051062W | 6930250003 | PRECITEC® DOUBLE NOZZLE Ø 1.2 | | |
| | 051063W | 6930250004 | PRECITEC® DOUBLE NOZZLE Ø 1.5 | | |
| | 051064W | | PRECITEC® DOUBLE NOZZLE Ø 1.8 | | |
| 2 | 051060CW | | PRECITEC® DOUBLE NOZZLE Ø 0.8 CP | | |
| | 051061CW | | PRECITEC® DOUBLE NOZZLE Ø 1.0 CP | | |
| | 051062CW | | PRECITEC® DOUBLE NOZZLE Ø 1.2 CP | | |
| | 051063CW | | PRECITEC® DOUBLE NOZZLE Ø 1.5 CP | | |
| | 051064CW | | PRECITEC® DOUBLE NOZZLE Ø 1.8 CP | | |

San Giorgio Plasma Parts srls is not affiliated with the named manufacturers. Reference to machines, parts, descriptions, and model numbers are for convenience in verifying compatibility only. All parts are made by or for San Giorgio Plasma Parts srls and are not made by the reference manufacturers (unless expressly indicated). All other trademarks are the properties of their respective owners."

Replacement parts suitable for PRECITEC®

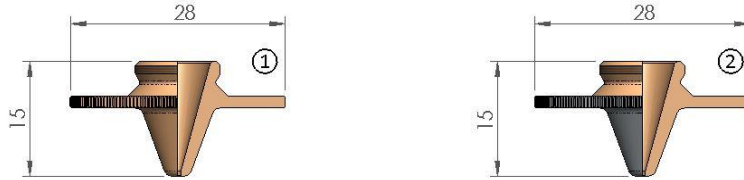

| POS | LS. CODE | ORIGINAL CODE | DESCRIPTION | unit price | 10 pack price |
|-----|----------|---------------|---------------------------|------------|---------------|
| 1 | 051070W | | PRECITEC® NOZZLE Ø 0.8 | | |
| | 051071W | | PRECITEC® NOZZLE Ø 1.0 | | |
| | 051072W | | PRECITEC® NOZZLE Ø 1.2 | | |
| | 051073W | | PRECITEC® NOZZLE Ø 1.5 | | |
| 2 | 051070CW | | PRECITEC® NOZZLE Ø 0.8 CP | | |
| | 051071CW | | PRECITEC® NOZZLE Ø 1.0 CP | | |
| | 051072CW | | PRECITEC® NOZZLE Ø 1.2 CP | | |
| | 051073CW | | PRECITEC® NOZZLE Ø 1.5 CP | | |

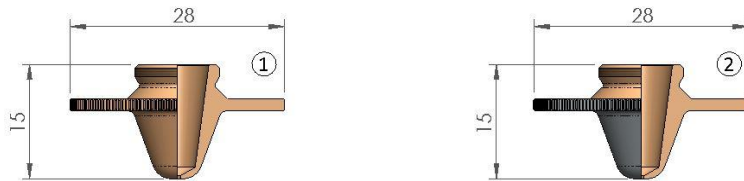

| POS | LS. CODE | ORIGINAL CODE | DESCRIPTION | unit price | 10 pack price |
|-----|----------|------------------|---------------------------|------------|---------------|
| 1 | 051080W | | PRECITEC® NOZZLE Ø 0.8 | | |
| | 051081W | | PRECITEC® NOZZLE Ø 1.0 | | |
| | 051082W | | PRECITEC® NOZZLE Ø 1.2 | | |
| | 051083W | P0591-1049-00015 | PRECITEC® NOZZLE Ø 1.5 | | |
| | 051084W | P0591-1050-00018 | PRECITEC® NOZZLE Ø 1.8 | | |
| | 051085W | | PRECITEC® NOZZLE Ø 2.0 | | |
| 2 | 051080CW | | PRECITEC® NOZZLE Ø 0.8 CP | | |
| | 051081CW | | PRECITEC® NOZZLE Ø 1.0 CP | | |
| | 051082CW | | PRECITEC® NOZZLE Ø 1.2 CP | | |
| | 051083CW | | PRECITEC® NOZZLE Ø 1.5 CP | | |
| | 051084CW | | PRECITEC® NOZZLE Ø 1.8 CP | | |
| | 051085CW | | PRECITEC® NOZZLE Ø 2.0 CP | | |

San Giorgio Plasma Parts srls is not affiliated with the named manufacturers. Reference to machines, parts, descriptions, and model numbers are for convenience in verifying compatibility only. All parts are made by or for San Giorgio Plasma Parts srls and are not made by the reference manufacturers (unless expressly indicated). All other trademarks are the properties of their respective owners."

Replacement parts suitable for PRECITEC®

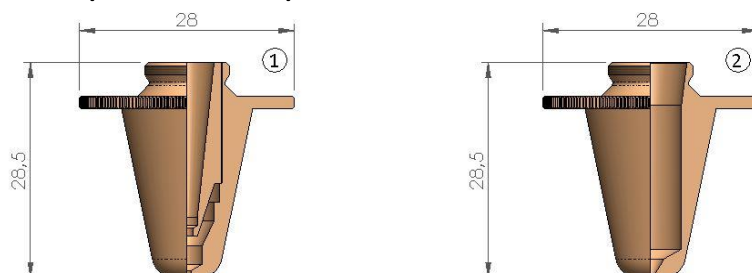

| POS | LS. CODE | ORIGINAL CODE | DESCRIPTION | unit price | 5 pack price |
|-----|----------|-----------------|-------------------------------|------------|--------------|
| 1 | 053025 | | PRECITEC® DOUBLE NOZZLE Ø 1.0 | | |
| | 053025V | | PRECITEC® DOUBLE NOZZLE Ø 1.0 | | |
| | 053026 | | PRECITEC® DOUBLE NOZZLE Ø 1.2 | | |
| | 053026V | | PRECITEC® DOUBLE NOZZLE Ø 1.2 | | |
| | 053027 | | PRECITEC® DOUBLE NOZZLE Ø 1.5 | | |
| | 053027V | | PRECITEC® DOUBLE NOZZLE Ø 1.5 | | |
| | 053028 | | PRECITEC® DOUBLE NOZZLE Ø 1.8 | | |
| | 053028V | | PRECITEC® DOUBLE NOZZLE Ø 1.8 | | |
| | 053029 | | PRECITEC® DOUBLE NOZZLE Ø 2.0 | | |
| | 053029V | | PRECITEC® DOUBLE NOZZLE Ø 2.0 | | |
| | 053030 | | PRECITEC® DOUBLE NOZZLE Ø 2.3 | | |
| | 053030V | | PRECITEC® DOUBLE NOZZLE Ø 2.3 | | |
| | 053031 | | PRECITEC® DOUBLE NOZZLE Ø 2.5 | | |
| | 053031V | | PRECITEC® DOUBLE NOZZLE Ø 2.5 | | |
| | 053032 | | PRECITEC® DOUBLE NOZZLE Ø 3.0 | | |
| | 053032V | | PRECITEC® DOUBLE NOZZLE Ø 3.0 | | |
| | 053033 | | PRECITEC® DOUBLE NOZZLE Ø 3.5 | | |
| | 053033V | | PRECITEC® DOUBLE NOZZLE Ø 3.5 | | |
| 2 | 053037 | P0573-563-00010 | PRECITEC® NOZZLE Ø 1.0 | | |
| | 053037V | P0573-563-00010 | PRECITEC® NOZZLE Ø 1.0 | | |
| | 053038 | P0573-563-00012 | PRECITEC® NOZZLE Ø 1.2 | | |
| | 053038V | P0573-563-00012 | PRECITEC® NOZZLE Ø 1.2 | | |
| | 053039 | P0573-563-00015 | PRECITEC® NOZZLE Ø 1.5 | | |
| | 053039V | P0573-563-00015 | PRECITEC® NOZZLE Ø 1.5 | | |
| | 053040 | | PRECITEC® NOZZLE Ø 1.8 | | |
| | 053040V | | PRECITEC® NOZZLE Ø 1.8 | | |
| | 053041 | P0573-564-00020 | PRECITEC® NOZZLE Ø 2.0 | | |
| | 053041V | P0573-564-00020 | PRECITEC® NOZZLE Ø 2.0 | | |
| | 053042 | P0573-566-00025 | PRECITEC® NOZZLE Ø 2.5 | | |
| | 053042V | P0573-566-00025 | PRECITEC® NOZZLE Ø 2.5 | | |
| | 053043 | | PRECITEC® NOZZLE Ø 3.0 | | |
| | 053043V | | PRECITEC® NOZZLE Ø 3.0 | | |

San Giorgio Plasma Parts srls is not affiliated with the named manufacturers. Reference to machines, parts, descriptions, and model numbers are for convenience in verifying compatibility only. All parts are made by or for San Giorgio Plasma Parts srls and are not made by the reference manufacturers (unless expressly indicated). All other trademarks are the properties of their respective owners."

Replacement parts suitable for PRECITEC®



| POS | LS. CODE | ORIGINAL CODE | DESCRIPTION | unit price | 10 pack price |
|-----|----------|---------------|------------------------------|------------|---------------|
| 1 | 052020W | | PRECITEC® NOZZLE Ø 1.0 HD | | |
| | 052021W | | PRECITEC® NOZZLE Ø 1.2 HD | | |
| | 052022W | | PRECITEC® NOZZLE Ø 1.5 HD | | |
| | 052023W | | PRECITEC® NOZZLE Ø 2.0 HD | | |
| | 052024W | | PRECITEC® NOZZLE Ø 2.5 HD | | |
| | 052025W | | PRECITEC® NOZZLE Ø 3.0 HD | | |
| | 052026W | | PRECITEC® NOZZLE Ø 3.5 HD | | |
| | 052027W | | PRECITEC® NOZZLE Ø 4.0 HD | | |
| | 052028W | | PRECITEC® NOZZLE Ø 4.5 HD | | |
| | 052029W | | PRECITEC® NOZZLE Ø 5.0 HD | | |
| 2 | 052020CW | | PRECITEC® NOZZLE Ø 1.0 HD CP | | |
| | 052021CW | | PRECITEC® NOZZLE Ø 1.2 HD CP | | |
| | 052022CW | | PRECITEC® NOZZLE Ø 1.5 HD CP | | |
| | 052023CW | | PRECITEC® NOZZLE Ø 2.0 HD | | |
| | 052024CW | | PRECITEC® NOZZLE Ø 2.5 HD CP | | |
| | 052025CW | | PRECITEC® NOZZLE Ø 3.0 HD CP | | |
| | 052026CW | | PRECITEC® NOZZLE Ø 3.5 HD CP | | |
| | 052027CW | | PRECITEC® NOZZLE Ø 4.0 HD CP | | |
| | 052028CW | | PRECITEC® NOZZLE Ø 4.0 HD CP | | |
| | 052029CW | | PRECITEC® NOZZLE Ø 5.0 HD CP | | |

Replacement parts suitable for PRECITEC®



| POS | LS. CODE | ORIGINAL CODE | DESCRIPTION | unit price | 10 pack price |
|-----|----------|---------------|------------------------------|------------|---------------|
| 1 | 052014W | | PRECITEC® NOZZLE Ø 1.5 HD | | |
| | 052015W | | PRECITEC® NOZZLE Ø 2.0 HD | | |
| | 052016W | | PRECITEC® NOZZLE Ø 2.5 HD | | |
| 2 | 052014CW | | PRECITEC® NOZZLE Ø 1.5 HD CP | | |
| | 052015CW | | PRECITEC® NOZZLE Ø 2.0 HD CP | | |
| | 052016CW | | PRECITEC® NOZZLE Ø 2.5 HD CP | | |

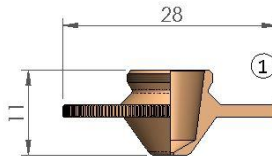

| POS | LS. CODE | ORIGINAL CODE | DESCRIPTION | unit price | 10 pack price |
|-----|----------|------------------------|------------------------|------------|---------------|
| 1 | 052032W | 281340/P0571-281-00010 | PRECITEC® NOZZLE Ø 1.0 | | |
| | 052033W | 281341/P0571-282-00012 | PRECITEC® NOZZLE Ø 1.2 | | |
| | 052034W | 281342/P0571-283-00015 | PRECITEC® NOZZLE Ø 1.5 | | |
| | 052035W | 281342/P0571-284-00018 | PRECITEC® NOZZLE Ø 1.8 | | |
| | 052036W | 281343/P0571-285-00020 | PRECITEC® NOZZLE Ø 2.0 | | |
| | 052037W | 281344/P0571-286-00025 | PRECITEC® NOZZLE Ø 2.5 | | |

Replacement parts suitable for PRECITEC®



| POS | LS. CODE | ORIGINAL CODE | DESCRIPTION | unit price | 10 pack price |
|-----|----------|------------------------|---------------------------|------------|---------------|
| 1 | 052040W | 281559/P0571-291-00010 | PRECITEC® NOZZLE Ø 1.0 | | |
| | 052041W | P0571-292-00012 | PRECITEC® NOZZLE Ø 1.2 | | |
| | 052042W | 281570/P0571-293-00015 | PRECITEC® NOZZLE Ø 1.5 | | |
| | 052043W | | PRECITEC® NOZZLE Ø 1.8 | | |
| | 052044W | 281571/P0571-295-00020 | PRECITEC® NOZZLE Ø 2.0 | | |
| | 052045W | 281572/P0571-297-00025 | PRECITEC® NOZZLE Ø 2.5 | | |
| | 052046W | | PRECITEC® NOZZLE Ø 3.0 | | |
| 2 | 052040CW | | PRECITEC® NOZZLE Ø 1.0 CP | | |
| | 052041CW | | PRECITEC® NOZZLE Ø 1.2 CP | | |
| | 052042CW | | PRECITEC® NOZZLE Ø 1.5 CP | | |
| | 052043CW | | PRECITEC® NOZZLE Ø 1.8 CP | | |
| | 052044CW | | PRECITEC® NOZZLE Ø 2.0 CP | | |
| | 052045CW | | PRECITEC® NOZZLE Ø 2.5 CP | | |
| | 052046CW | | PRECITEC® NOZZLE Ø 3.0 CP | | |

Replacement parts suitable for PRECITEC®



| POS | LS. CODE | ORIGINAL CODE | DESCRIPTION | unit price | 10 pack price |
|----------|----------|---------------|----------------------------------|----------------------------------|---------------|
| 1 | 052002W | | PRECITEC® DOUBLE NOZZLE Ø 1.0 | | |
| | 052003W | | PRECITEC® DOUBLE NOZZLE Ø 1.2 | | |
| | 052004W | | PRECITEC® DOUBLE NOZZLE Ø 1.4 | | |
| | 052005W | | PRECITEC® DOUBLE NOZZLE Ø 1.5 | | |
| | 052006W | | PRECITEC® DOUBLE NOZZLE Ø 1.8 | | |
| | 052007W | | PRECITEC® DOUBLE NOZZLE Ø 2.0 | | |
| | 052008W | | PRECITEC® DOUBLE NOZZLE Ø 2.5 | | |
| | 052009W | | PRECITEC® DOUBLE NOZZLE Ø 3.0 | | |
| | 052010W | | PRECITEC® DOUBLE NOZZLE Ø 3.5 | | |
| | 2 | 052002CW | | PRECITEC® DOUBLE NOZZLE Ø 1.0 CP | |
| 052003CW | | | PRECITEC® DOUBLE NOZZLE Ø 1.2 CP | | |
| 052004CW | | | PRECITEC® DOUBLE NOZZLE Ø 1.4 CP | | |
| 052005CW | | | PRECITEC® DOUBLE NOZZLE Ø 1.5 CP | | |
| 052006CW | | | PRECITEC® DOUBLE NOZZLE Ø 1.8 CP | | |
| 052007CW | | | PRECITEC® DOUBLE NOZZLE Ø 2.0 CP | | |
| 052008CW | | | PRECITEC® DOUBLE NOZZLE Ø 2.5 CP | | |
| 052009CW | | | PRECITEC® DOUBLE NOZZLE Ø 3.0 CP | | |
| 052010CW | | | PRECITEC® DOUBLE NOZZLE Ø 3.5 CP | | |

Replacement parts suitable for PRECITEC®

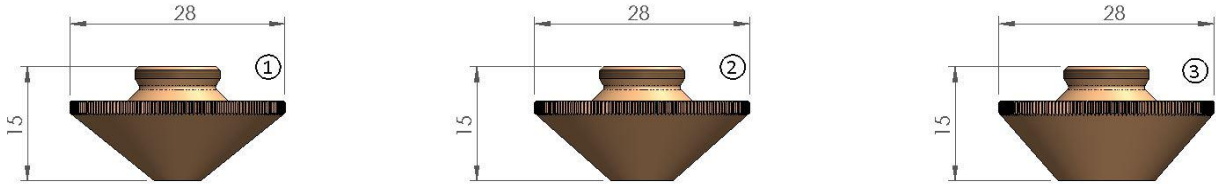

| POS | LS. CODE | ORIGINAL CODE | DESCRIPTION | unit price | 10 pack price |
|-----|----------|---------------|-------------------------------------|------------|---------------|
| 1 | 056001 | | PRECITEC® DOUBLE NOZZLE Ø 2.5 - SS | | |
| | 056002 | | PRECITEC® DOUBLE NOZZLE Ø 3.0 - SS | | |
| | 056003 | | PRECITEC® DOUBLE NOZZLE Ø 4.0 - SS | | |
| 2 | 056004 | | PRECITEC® DOUBLE NOZZLE Ø 6.0 - SS | | |
| 3 | 056005 | | PRECITEC® DOUBLE NOZZLE Ø 10.0 - SS | | |

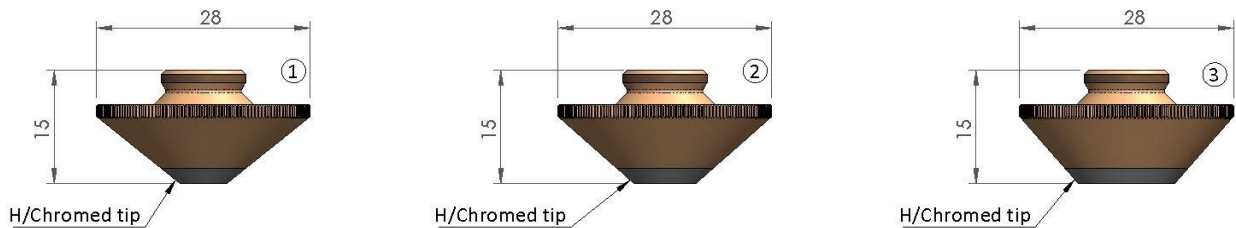

| POS | LS. CODE | ORIGINAL CODE | DESCRIPTION | unit price | 10 pack price |
|-----|----------|---------------|--|------------|---------------|
| 1 | 056001CK | | PRECITEC® DOUBLE NOZZLE Ø 2.5 CP - SS | | |
| | 056002CK | | PRECITEC® DOUBLE NOZZLE Ø 3.0 CP - SS | | |
| | 056003CK | | PRECITEC® DOUBLE NOZZLE Ø 4.0 CP - SS | | |
| 2 | 056004CK | | PRECITEC® DOUBLE NOZZLE Ø 6.0 CP - SS | | |
| 3 | 056005CK | | PRECITEC® DOUBLE NOZZLE Ø 10.0 CP - SS | | |

San Giorgio Plasma Parts srls is not affiliated with the named manufacturers. Reference to machines, parts, descriptions, and model numbers are for convenience in verifying compatibility only. All parts are made by or for San Giorgio Plasma Parts srls and are not made by the reference manufacturers (unless expressly indicated). All other trademarks are the properties of their respective owners."

Replacement parts suitable for PRECITEC®

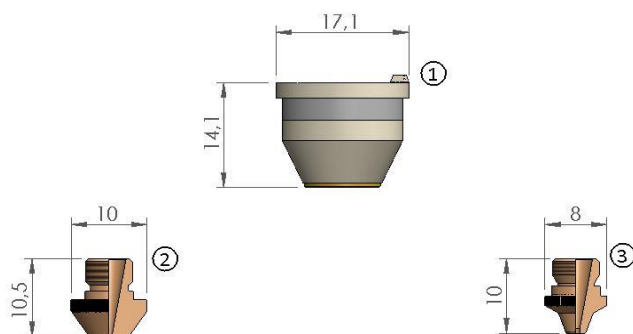

| POS | LS. CODE | ORIGINAL CODE | DESCRIPTION | unit price | 10 pack price |
|-----|----------|--------------------------------|--|------------|---------------|
| 1 | 059010 | 280408- P0494-752-00001-092405 | PRECITEC® ORIGINAL NOZZLE HOLDER KT M1,5" KN | | |
| 2 | 054002W | | PRECITEC® NOZZLE Ø 0.8 | | |
| | 054003W | 280551-P0494-853-00010 | PRECITEC® NOZZLE Ø 1.0 | | |
| | 054004W | 280552-P0494-854-00012 | PRECITEC® NOZZLE Ø 1.2 | | |
| | 054005W | 280553-P0494-855-00015 | PRECITEC® NOZZLE Ø 1.5 | | |
| | 054006W | 280554-P0494-856-00017 | PRECITEC® NOZZLE Ø 1.7 | | |
| | 054007W | 280555-èP0494-857-00020 | PRECITEC® NOZZLE Ø 2.0 | | |
| | 054008W | | PRECITEC® NOZZLE Ø 2.3 | | |
| | 054009W | | PRECITEC® NOZZLE Ø 2.5 | | |
| | 054010W | | PRECITEC® NOZZLE Ø 3.0 | | |
| | 054011W | | PRECITEC® NOZZLE Ø 4.0 | | |
| 3 | 054016W | 280943-P0494-787-00010 | PRECITEC® NOZZLE Ø 1.0 | | |
| | 054017W | 280942-P0494-788-00012 | PRECITEC® NOZZLE Ø 1.2 | | |
| | 054018W | 280941-P0494-789-00015 | PRECITEC® NOZZLE Ø 1.5 | | |
| | 054019W | | PRECITEC® NOZZLE Ø 1.8 | | |
| | 054020W | | PRECITEC® NOZZLE Ø 2.0 | | |

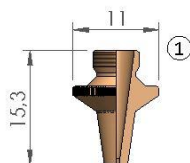

| POS | LS. CODE | ORIGINAL CODE | DESCRIPTION | unit price | 10 pack price |
|-----|----------|------------------|------------------------|------------|---------------|
| 1 | 054025W | | PRECITEC® NOZZLE Ø 1.0 | | |
| | 054026W | P0787-483-00012 | PRECITEC® NOZZLE Ø 1.2 | | |
| | 054027W | P0787-483-00015 | PRECITEC® NOZZLE Ø 1.5 | | |
| | 054028W | | PRECITEC® NOZZLE Ø 1.7 | | |
| | 054029W | P0787-1001-00020 | PRECITEC® NOZZLE Ø 2.0 | | |
| | 054030W | | PRECITEC® NOZZLE Ø 2.5 | | |

San Giorgio Plasma Parts srls is not affiliated with the named manufacturers. Reference to machines, parts, descriptions, and model numbers are for convenience in verifying compatibility only. All parts are made by or for San Giorgio Plasma Parts srls and are not made by the reference manufacturers (unless expressly indicated). All other trademarks are the properties of their respective owners."

Replacement parts suitable for PRECITEC®

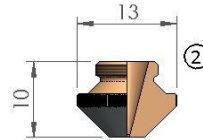
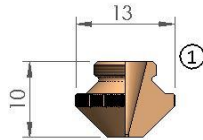

| POS | LS. CODE | ORIGINAL CODE | DESCRIPTION | unit price | 10 pack price |
|-----|----------|-------------------------------|---------------------------|------------|---------------|
| 1 | 055020W | 280013, P0492-441-00008, W222 | PRECITEC® NOZZLE Ø 0.8 | | |
| | 055021W | 280014, P0492-442-00010, W223 | PRECITEC® NOZZLE Ø 1.0 | | |
| | 055022W | 280015, P0492-443-00012, W228 | PRECITEC® NOZZLE Ø 1.2 | | |
| | 055023W | 280016, P0492-444-00015, W224 | PRECITEC® NOZZLE Ø 1.5 | | |
| | 055024W | P0492-447-00018 | PRECITEC® NOZZLE Ø 1.8 | | |
| | 055025W | 280937, P0492-445-00020, W225 | PRECITEC® NOZZLE Ø 2.0 | | |
| | 055026W | P0492-448-00023 | PRECITEC® NOZZLE Ø 2.3 | | |
| | 055027W | 281791, P0492-446-00025, W226 | PRECITEC® NOZZLE Ø 2,5 | | |
| | 055028W | | PRECITEC® NOZZLE Ø 3.0 | | |
| 2 | 055020CW | 280013, P0492-441-00008, W222 | PRECITEC® NOZZLE Ø 0.8 CP | | |
| | 055021CW | 280014, P0492-442-00010, W223 | PRECITEC® NOZZLE Ø 1.0 CP | | |
| | 055022CW | 280015, P0492-443-00012, W228 | PRECITEC® NOZZLE Ø 1.2 CP | | |
| | 055023CW | 280016, P0492-444-00015, W224 | PRECITEC® NOZZLE Ø 1.5 CP | | |
| | 055024CW | P0492-447-00018 | PRECITEC® NOZZLE Ø 1.8 CP | | |
| | 055025CW | 280937, P0492-445-00020, W225 | PRECITEC® NOZZLE Ø 2.0 CP | | |
| | 055026CW | P0492-448-00023 | PRECITEC® NOZZLE Ø 2.3 CP | | |
| | 055027CW | 281791, P0492-446-00025, W226 | PRECITEC® NOZZLE Ø 2,5 CP | | |
| | 055028CW | | PRECITEC® NOZZLE Ø 3.0 CP | | |

Replacement parts suitable for PRECITEC®

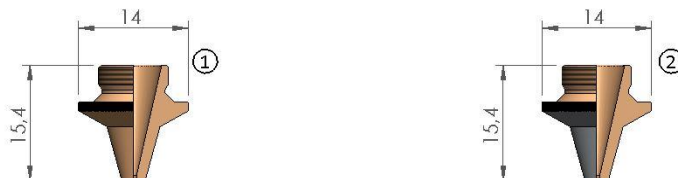

| POS | LS. CODE | ORIGINAL CODE | DESCRIPTION | unit price | 10 pack price |
|-----|----------|-------------------------|---------------------------|------------|---------------|
| 1 | 055014W | 281813, P0589-424-00008 | PRECITEC® NOZZLE Ø 0.8 | | |
| | 055015W | 281789, P0589-426-00010 | PRECITEC® NOZZLE Ø 1.0 | | |
| | 055016W | 281561, 778550 | PRECITEC® NOZZLE Ø 1.2 | | |
| | 055017W | 281814, 149957 | PRECITEC® NOZZLE Ø 1.5 | | |
| | 055018W | P0589-428-00020 | PRECITEC® NOZZLE Ø 2.0 | | |
| 2 | 055014CW | 281813, P0589-424-00008 | PRECITEC® NOZZLE Ø 0.8 CP | | |
| | 055015CW | 281789, P0589-426-00010 | PRECITEC® NOZZLE Ø 1.0 CP | | |
| | 055016CW | 281561, 778550 | PRECITEC® NOZZLE Ø 1.2 CP | | |
| | 055017CW | 281814, 149957 | PRECITEC® NOZZLE Ø 1.5 CP | | |
| | 055018CW | P0589-428-00020 | PRECITEC® NOZZLE Ø 2.0 CP | | |

| POS | LS. CODE | ORIGINAL CODE | DESCRIPTION | unit price | 10 pack price |
|-----|----------|-----------------|--|------------|---------------|
| | 059030 | P0360-240-20000 | PRECITEC® ORIGINAL SENSOR CABLE KS 20M GW Z PU | | |
| | 059031 | P0360-210-00600 | PRECITEC® ELECTRODE CABLE 600MM GW | | |
| | 059032 | P0360-600-00320 | PRECITEC® ORIGINAL CABLE KE 320 gg | | |
| | 059033 | P0360-100-00500 | PRECITEC® ORIGINAL ELECTRODE CABLE 500MM GG Z | | |
| | 059034 | P0360-156-00200 | PRECITEC® ORIGINAL SENSOR CABLE 200MM | | |
| | 059035 | P0492-001-00130 | PRECITEC® ORIGINAL SENSOR CABLE KE 130 GW | | |

San Giorgio Plasma Parts srls is not affiliated with the named manufacturers. Reference to machines, parts, descriptions, and model numbers are for convenience in verifying compatibility only. All parts are made by or for San Giorgio Plasma Parts srls and are not made by the reference manufacturers (unless expressly indicated). All other trademarks are the properties of their respective owners."