

Replacement parts suitable for PRECITEC®

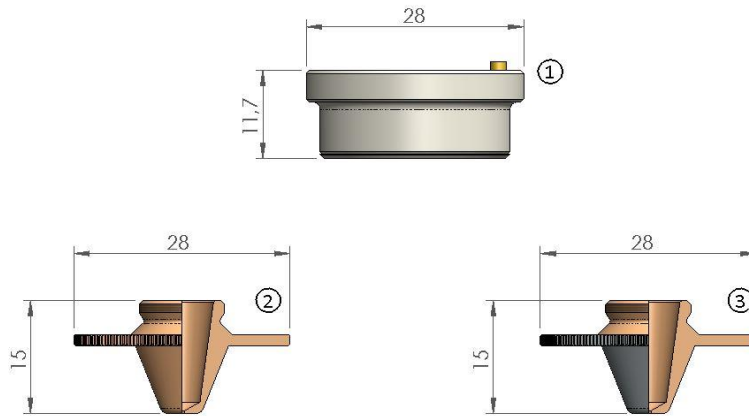

POS	LS. CODE	ORIGINAL CODE	DESCRIPTION	unit price	10 pack price
1	059001	281330, P0571-260-00001, 6930281330	PRECITEC® ORIGINAL NOZZLE HOLDER KT B2"		
	059004	P0571-260-00001	PRECITEC® NOZZLE HOLDER KT B2"		
	059002	P0571-1051-00001, 6930281333	PRECITEC® ORIGINAL NOZZLE HOLDER KT B2" CON		
	059003	P0571-1051-00001, 6930281333-080800302	PRECITEC® NOZZLE HOLDER KT B2" CON		
2	051046W	281590-P0591-569-00008	PRECITEC® NOZZLE Ø 0.8		
	051047W	281331-P0591-561-00010	PRECITEC® NOZZLE Ø 1.0		
	051048W	281351-P0591-562-00012	PRECITEC® NOZZLE Ø 1.2		
	051049W	281352-P0591-563-00015	PRECITEC® NOZZLE Ø 1.5		
	051050W		PRECITEC® NOZZLE Ø 1.7		
	051051W	281353-P0591-564-00018	PRECITEC® NOZZLE Ø 1.8		
	051052W	281354-P0591-565-00020	PRECITEC® NOZZLE Ø 2.0		
	051053W		PRECITEC® NOZZLE Ø 2.3		
	051054W	281591-P0591-566-00025	PRECITEC® NOZZLE Ø 2.5		
	051055W		PRECITEC® NOZZLE Ø 2.7		
	051056W		PRECITEC® NOZZLE Ø 3.0		
	3	051046CW	281590-P0591-569-00008	PRECITEC® NOZZLE Ø 0.8 CP	
051047CW		281331-P0591-561-00010	PRECITEC® NOZZLE Ø 1.0 CP		
051048CW		281351-P0591-562-00012	PRECITEC® NOZZLE Ø 1.2 CP		
051049CW		281352-P0591-563-00015	PRECITEC® NOZZLE Ø 1.5 CP		
051050CW			PRECITEC® NOZZLE Ø 1.7 CP		
051051CW		281353-P0591-564-00018	PRECITEC® NOZZLE Ø 1.8 CP		
051052CW		281354-P0591-565-00020	PRECITEC® NOZZLE Ø 2.0 CP		
051053CW			PRECITEC® NOZZLE Ø 2.3 CP		
051054CW		281591-P0591-566-00025	PRECITEC® NOZZLE Ø 2.5 CP		
051055CW			PRECITEC® NOZZLE Ø 2.7 CP		
051056CW		PRECITEC® NOZZLE Ø 3.0 CP			

San Giorgio Plasma Parts srls is not affiliated with the named manufacturers. Reference to machines, parts, descriptions, and model numbers are for convenience in verifying compatibility only. All parts are made by or for San Giorgio Plasma Parts srls and are not made by the reference manufacturers (unless expressly indicated). All other trademarks are the properties of their respective owners."

Replacement parts suitable for PRECITEC®

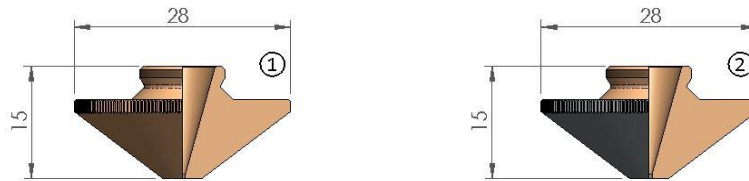

POS	LS. CODE	ORIGINAL CODE	DESCRIPTION	unit price	10 pack price
1	051002W		PRECITEC® NOZZLE Ø 0.8 HD		
	051003W	281548-P0591-571-00010-29100233	PRECITEC® NOZZLE Ø 1.0 HD		
	051004W	281549-P0591-572-00012-29100234	PRECITEC® NOZZLE Ø 1.2 HD		
	051005W		PRECITEC® NOZZLE Ø 1.4 HD		
	051006W	P0591-573-00015-281463-29100235-080800230	PRECITEC® NOZZLE Ø 1.5 HD		
	051007W	P0591-574-00018-29100236	PRECITEC® NOZZLE Ø 1.8 HD		
	051008W	10.03.11.09.011-281550-P0591-575-00020-29100237-080800231	PRECITEC® NOZZLE Ø 2.0 HD		
	051009W		PRECITEC® NOZZLE Ø 2.3 HD		
	051010W	10.03.11.09.012-281551-P0591-576-00025-29100239-080800232	PRECITEC® NOZZLE Ø 2.5 HD		
	051011W		PRECITEC® NOZZLE Ø 2.75 HD		
	051012W	P0591-577-00030	PRECITEC® NOZZLE Ø 3.0 HD		
	051013W		PRECITEC® NOZZLE Ø 3.2 HD		
	051014W	10.03.11.09.014-29100243-08	PRECITEC® NOZZLE Ø 3.5 HD		
	051015W		PRECITEC® NOZZLE Ø 4.0 HD		
	051016W		PRECITEC® NOZZLE Ø 4.5 HD		
	051017W		PRECITEC® NOZZLE Ø 5.0 HD		
	2	051002CW		PRECITEC® NOZZLE Ø 0.8 HD CP	
051003CW		281548-P0591-571-00010	PRECITEC® NOZZLE Ø 1.0 HD CP		
051004CW		281549-P0591-572-00012	PRECITEC® NOZZLE Ø 1.2 HD CP		
051005CW			PRECITEC® NOZZLE Ø 1.4 HD CP		
051006CW		281463-P0591-573-00015	PRECITEC® NOZZLE Ø 1.5 HD CP		
051007CW		P0591-574-00018	PRECITEC® NOZZLE Ø 1.8 HD CP		
051008CW		281550-P0591-575-00020	PRECITEC® NOZZLE Ø 2.0 HD CP		
051009CW			PRECITEC® NOZZLE Ø 2.3 HD CP		
051010CW		281551-P0591-576-00025	PRECITEC® NOZZLE Ø 2.5 HD CP		
051011CW			PRECITEC® NOZZLE Ø 2.75 HD CP		
051012CW			PRECITEC® NOZZLE Ø 3.0 HD CP		
051013CW			PRECITEC® NOZZLE Ø 3.2 HD CP		
051014CW			PRECITEC® NOZZLE Ø 3.5 HD CP		
051015CW			PRECITEC® NOZZLE Ø 4.0 HD CP		
051016CW			PRECITEC® NOZZLE Ø 4.5 HD CP		
051017CW			PRECITEC® NOZZLE Ø 5.0 HD CP		

San Giorgio Plasma Parts srls is not affiliated with the named manufacturers. Reference to machines, parts, descriptions, and model numbers are for convenience in verifying compatibility only. All parts are made by or for San Giorgio Plasma Parts srls and are not made by the reference manufactures (unless expressly indicated). All other trademarks are the properties of their respective owners."

Replacement parts suitable for PRECITEC®

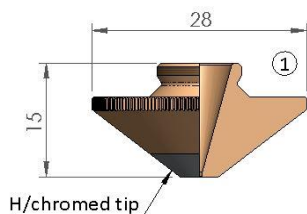

POS	LS. CODE	ORIGINAL CODE	DESCRIPTION	unit price	10 pack price
1	051002CK		PRECITEC® NOZZLE Ø 0.8 HD CP		
	051002CKW		PRECITEC® NOZZLE Ø 0.8 HD CP		
	051003CK		PRECITEC® NOZZLE Ø 1.0 HD CP		
	051003CKW		PRECITEC® NOZZLE Ø 1.0 HD CP		
	051004CK		PRECITEC® NOZZLE Ø 1.2 HD CP		
	051004CKW		PRECITEC® NOZZLE Ø 1.2 HD CP		
	051005CK		PRECITEC® NOZZLE Ø 1.4 HD CP		
	051005CKW		PRECITEC® NOZZLE Ø 1.4 HD CP		
	051006CK		PRECITEC® NOZZLE Ø 1.5 HD CP		
	051006CKW		PRECITEC® NOZZLE Ø 1.5 HD CP		
	051007CK		PRECITEC® NOZZLE Ø 1.8 HD CP		
	051007CKW		PRECITEC® NOZZLE Ø 1.8 HD CP		
	051008CK		PRECITEC® NOZZLE Ø 2.0 HD CP		
	051008CKW		PRECITEC® NOZZLE Ø 2.0 HD CP		
	051009CK		PRECITEC® NOZZLE Ø 2.3 HD CP		
	051009CKW		PRECITEC® NOZZLE Ø 2.3 HD CP		
	051010CK		PRECITEC® NOZZLE Ø 2.5 HD CP		
	051010CKW		PRECITEC® NOZZLE Ø 2.5 HD CP		
	051011CK		PRECITEC® NOZZLE Ø 2.75 HD CP		
	051011CKW		PRECITEC® NOZZLE Ø 2.75 HD CP		
	051012CK		PRECITEC® NOZZLE Ø 3.0 HD CP		
	051012CKW		PRECITEC® NOZZLE Ø 3.0 HD CP		
	051013CK		PRECITEC® NOZZLE Ø 3.2 HD CP		
	051013CKW		PRECITEC® NOZZLE Ø 3.2 HD CP		
	051014CK		PRECITEC® NOZZLE Ø 3.5 HD CP		
	051014CKW		PRECITEC® NOZZLE Ø 3.5 HD CP		
	051015CK		PRECITEC® NOZZLE Ø 4.0 HD CP		
	051015CKW		PRECITEC® NOZZLE Ø 4.0 HD CP		
	051016CK		PRECITEC® NOZZLE Ø 4.5 HD CP		
	051016CKW		PRECITEC® NOZZLE Ø 4.5 HD CP		
	051017CK		PRECITEC® NOZZLE Ø 5.0 HD CP		
	051017CKW		PRECITEC® NOZZLE Ø 5.0 HD CP		

San Giorgio Plasma Parts srls is not affiliated with the named manufacturers. Reference to machines, parts, descriptions, and model numbers are for convenience in verifying compatibility only. All parts are made by or for San Giorgio Plasma Parts srls and are not made by the reference manufacturers (unless expressly indicated). All other trademarks are the properties of their respective owners."

Replacement parts suitable for PRECITEC®

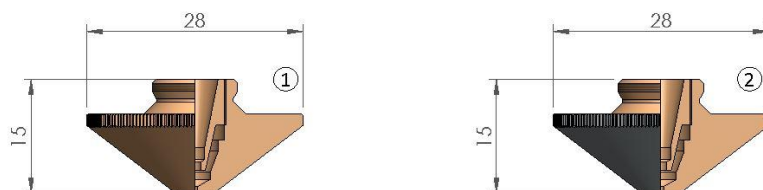

POS	LS. CODE	ORIGINAL CODE	DESCRIPTION	unit price	10 pack price
1	051024W		PRECITEC® DOUBLE NOZZLE Ø 0.8		
	051025W	P0591-002-00010	PRECITEC® DOUBLE NOZZLE Ø 1.0		
	051026W	P0591-002-00012	PRECITEC® DOUBLE NOZZLE Ø 1.2		
	051027W		PRECITEC® DOUBLE NOZZLE Ø 1.4		
	051028W	P0591-002-00015	PRECITEC® DOUBLE NOZZLE Ø 1.5		
	051029W	10.03.11.09.031/P0591-002-00018	PRECITEC® DOUBLE NOZZLE Ø 1.8		
	051030W	P0591-002-00020	PRECITEC® DOUBLE NOZZLE Ø 2.0		
	051031W	P0591-002-00023	PRECITEC® DOUBLE NOZZLE Ø 2.3		
	051032W	P0591-002-00025	PRECITEC® DOUBLE NOZZLE Ø 2.5		
	051038W		PRECITEC® DOUBLE NOZZLE Ø 2.7		
	051033W	P0591-002-00030	PRECITEC® DOUBLE NOZZLE Ø 3.0		
	051034W	P0591-002-00035-29100384	PRECITEC® DOUBLE NOZZLE Ø 3.5		
	051035W	P0591-002-00040	PRECITEC® DOUBLE NOZZLE Ø 4.0		
	051036W		PRECITEC® DOUBLE NOZZLE Ø 4.5		
	051037W	10.03.11.09.029-080	PRECITEC® DOUBLE NOZZLE Ø 5.0		
2	051024CW		PRECITEC® DOUBLE NOZZLE Ø 0.8 CP		
	051025CW		PRECITEC® DOUBLE NOZZLE Ø 1.0 CP		
	051026CW		PRECITEC® DOUBLE NOZZLE Ø 1.2 CP		
	051027CW		PRECITEC® DOUBLE NOZZLE Ø 1.4 CP		
	051028CW		PRECITEC® DOUBLE NOZZLE Ø 1.5 CP		
	051029CW		PRECITEC® DOUBLE NOZZLE Ø 1.8 CP		
	051030CW		PRECITEC® DOUBLE NOZZLE Ø 2.0 CP		
	051031CW		PRECITEC® DOUBLE NOZZLE Ø 2.3 CP		
	051032CW		PRECITEC® DOUBLE NOZZLE Ø 2.5 CP		
	051038CW		PRECITEC® DOUBLE NOZZLE Ø 2.7 CP		
	051033CW		PRECITEC® DOUBLE NOZZLE Ø 3.0 CP		
	051034CW		PRECITEC® DOUBLE NOZZLE Ø 3.5 CP		
	051035CW		PRECITEC® DOUBLE NOZZLE Ø 4.0 CP		
	051036CW		PRECITEC® DOUBLE NOZZLE Ø 4.5 CP		
	051037CW		PRECITEC® DOUBLE NOZZLE Ø 5.0 CP		

San Giorgio Plasma Parts srls is not affiliated with the named manufacturers. Reference to machines, parts, descriptions, and model numbers are for convenience in verifying compatibility only. All parts are made by or for San Giorgio Plasma Parts srls and are not made by the reference manufacturers (unless expressly indicated). All other trademarks are the properties of their respective owners."

Replacement parts suitable for PRECITEC®

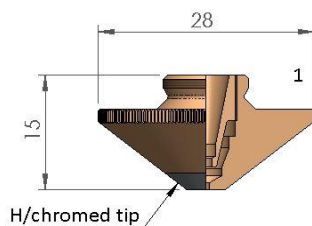

POS	LS. CODE	ORIGINAL CODE	DESCRIPTION	unit price	10 pack price
1	051024CK		PRECITEC® DOUBLE NOZZLE Ø 0.8 CP		
	051024CKW		PRECITEC® DOUBLE NOZZLE Ø 0.8 CP		
	051025CK		PRECITEC® DOUBLE NOZZLE Ø 1.0 CP		
	051025CKW		PRECITEC® DOUBLE NOZZLE Ø 1.0 CP		
	051026CK		PRECITEC® DOUBLE NOZZLE Ø 1.2 CP		
	051026CKW		PRECITEC® DOUBLE NOZZLE Ø 1.2 CP		
	051027CK		PRECITEC® DOUBLE NOZZLE Ø 1.4 CP		
	051027CKW		PRECITEC® DOUBLE NOZZLE Ø 1.4 CP		
	051028CK		PRECITEC® DOUBLE NOZZLE Ø 1.5 CP		
	051028CKW		PRECITEC® DOUBLE NOZZLE Ø 1.5 CP		
	051029CK		PRECITEC® DOUBLE NOZZLE Ø 1.8 CP		
	051029CKW		PRECITEC® DOUBLE NOZZLE Ø 1.8 CP		
	051030CK		PRECITEC® DOUBLE NOZZLE Ø 2.0 CP		
	051030CKW		PRECITEC® DOUBLE NOZZLE Ø 2.0 CP		
	051031CK		PRECITEC® DOUBLE NOZZLE Ø 2.3 CP		
	051031CKW		PRECITEC® DOUBLE NOZZLE Ø 2.3 CP		
	051032CK		PRECITEC® DOUBLE NOZZLE Ø 2.5 CP		
	051032CKW		PRECITEC® DOUBLE NOZZLE Ø 2.5 CP		
	051038CK		PRECITEC® DOUBLE NOZZLE Ø 2.7 CP		
	051038CKW		PRECITEC® DOUBLE NOZZLE Ø 2.7 CP		
	051033CK		PRECITEC® DOUBLE NOZZLE Ø 3.0 CP		
	051033CKW		PRECITEC® DOUBLE NOZZLE Ø 3.0 CP		
	051034CK		PRECITEC® DOUBLE NOZZLE Ø 3.5 CP		
	051034CKW		PRECITEC® DOUBLE NOZZLE Ø 3.5 CP		
	051035CK		PRECITEC® DOUBLE NOZZLE Ø 4.0 CP		
	051035CKW		PRECITEC® DOUBLE NOZZLE Ø 4.0 CP		
	051036CK		PRECITEC® DOUBLE NOZZLE Ø 4.5 CP		
	051036CKW		PRECITEC® DOUBLE NOZZLE Ø 4.5 CP		
	051037CK		PRECITEC® DOUBLE NOZZLE Ø 5.0 CP		
	051037CKW		PRECITEC® DOUBLE NOZZLE Ø 5.0 CP		

San Giorgio Plasma Parts srls is not affiliated with the named manufacturers. Reference to machines, parts, descriptions, and model numbers are for convenience in verifying compatibility only. All parts are made by or for San Giorgio Plasma Parts srls and are not made by the reference manufacturers (unless expressly indicated). All other trademarks are the properties of their respective owners."

Replacement parts suitable for PRECITEC®

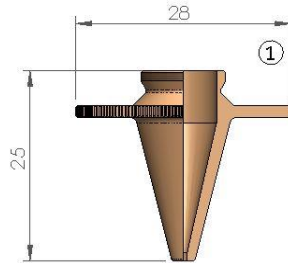

POS	LS. CODE	ORIGINAL CODE	DESCRIPTION	unit price	10 pack price
	053008		PRECITEC® NOZZLE LONG Ø 1.0		
	053009		PRECITEC® NOZZLE LONG Ø 1.5		
	053010		PRECITEC® NOZZLE LONG Ø 1.8		
	053011		PRECITEC® NOZZLE LONG Ø 2.0		

Replacement parts suitable for PRECITEC®

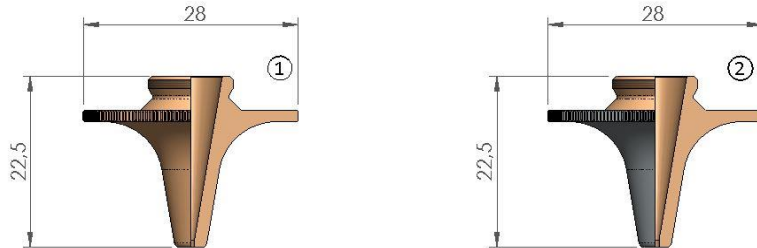

POS	LS. CODE	ORIGINAL CODE	DESCRIPTION	unit price	10 pack price
1	053002	P0578-0411-00010	PRECITEC® NOZZLE RADIUS LONG Ø 1.0		
	053003	P0578-0412-00012	PRECITEC® NOZZLE RADIUS LONG Ø 1.2		
	053004	P0578-0413-00015 / 6930300039	PRECITEC® NOZZLE RADIUS LONG Ø 1.5		
	053005	P0578-0414-00018	PRECITEC® NOZZLE RADIUS LONG Ø 1.8		
	053006	P0578-0415-00020 / 6930300040	PRECITEC® NOZZLE RADIUS LONG Ø 2.0		
	053007	P0578-0417-00025	PRECITEC® NOZZLE RADIUS LONG Ø 2.5		
2	053002C		PRECITEC® NOZZLE RADIUS LONG Ø 1.0 CP		
	053003C		PRECITEC® NOZZLE RADIUS LONG Ø 1.2 CP		
	053004C		PRECITEC® NOZZLE RADIUS LONG Ø 1.5 CP		
	053005C		PRECITEC® NOZZLE RADIUS LONG Ø 1.8 CP		
	053006C		PRECITEC® NOZZLE RADIUS LONG Ø 2.0 CP		
	053007C		PRECITEC® NOZZLE RADIUS LONG Ø 2.5 CP		

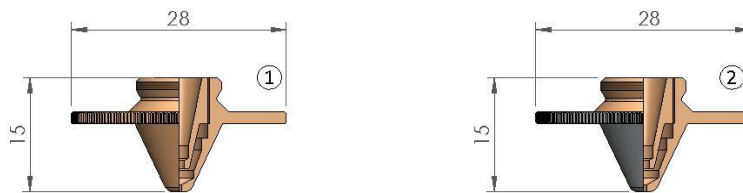

POS	LS. CODE	ORIGINAL CODE	DESCRIPTION	unit price	10 pack price
1	051060W	6930250001	PRECITEC® DOUBLE NOZZLE Ø 0.8		
	051061W	6930250002	PRECITEC® DOUBLE NOZZLE Ø 1.0		
	051062W	6930250003	PRECITEC® DOUBLE NOZZLE Ø 1.2		
	051063W	6930250004	PRECITEC® DOUBLE NOZZLE Ø 1.5		
	051064W		PRECITEC® DOUBLE NOZZLE Ø 1.8		
2	051060CW		PRECITEC® DOUBLE NOZZLE Ø 0.8 CP		
	051061CW		PRECITEC® DOUBLE NOZZLE Ø 1.0 CP		
	051062CW		PRECITEC® DOUBLE NOZZLE Ø 1.2 CP		
	051063CW		PRECITEC® DOUBLE NOZZLE Ø 1.5 CP		
	051064CW		PRECITEC® DOUBLE NOZZLE Ø 1.8 CP		

San Giorgio Plasma Parts srls is not affiliated with the named manufacturers. Reference to machines, parts, descriptions, and model numbers are for convenience in verifying compatibility only. All parts are made by or for San Giorgio Plasma Parts srls and are not made by the reference manufacturers (unless expressly indicated). All other trademarks are the properties of their respective owners."

Replacement parts suitable for PRECITEC®

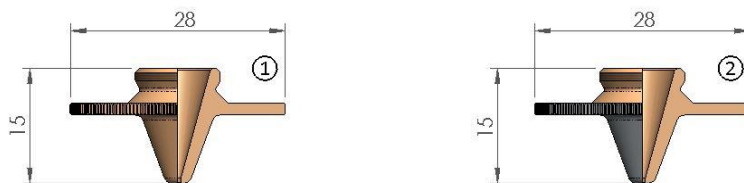

POS	LS. CODE	ORIGINAL CODE	DESCRIPTION	unit price	10 pack price
1	051070W		PRECITEC® NOZZLE Ø 0.8		
	051071W		PRECITEC® NOZZLE Ø 1.0		
	051072W		PRECITEC® NOZZLE Ø 1.2		
	051073W		PRECITEC® NOZZLE Ø 1.5		
2	051070CW		PRECITEC® NOZZLE Ø 0.8 CP		
	051071CW		PRECITEC® NOZZLE Ø 1.0 CP		
	051072CW		PRECITEC® NOZZLE Ø 1.2 CP		
	051073CW		PRECITEC® NOZZLE Ø 1.5 CP		

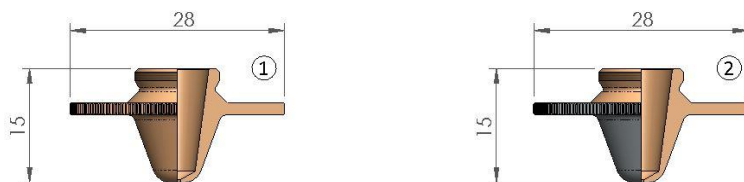

POS	LS. CODE	ORIGINAL CODE	DESCRIPTION	unit price	10 pack price
1	051080W		PRECITEC® NOZZLE Ø 0.8		
	051081W		PRECITEC® NOZZLE Ø 1.0		
	051082W		PRECITEC® NOZZLE Ø 1.2		
	051083W	P0591-1049-00015	PRECITEC® NOZZLE Ø 1.5		
	051084W	P0591-1050-00018	PRECITEC® NOZZLE Ø 1.8		
	051085W		PRECITEC® NOZZLE Ø 2.0		
2	051080CW		PRECITEC® NOZZLE Ø 0.8 CP		
	051081CW		PRECITEC® NOZZLE Ø 1.0 CP		
	051082CW		PRECITEC® NOZZLE Ø 1.2 CP		
	051083CW		PRECITEC® NOZZLE Ø 1.5 CP		
	051084CW		PRECITEC® NOZZLE Ø 1.8 CP		
	051085CW		PRECITEC® NOZZLE Ø 2.0 CP		

San Giorgio Plasma Parts srls is not affiliated with the named manufacturers. Reference to machines, parts, descriptions, and model numbers are for convenience in verifying compatibility only. All parts are made by or for San Giorgio Plasma Parts srls and are not made by the reference manufacturers (unless expressly indicated). All other trademarks are the properties of their respective owners."

Replacement parts suitable for PRECITEC®

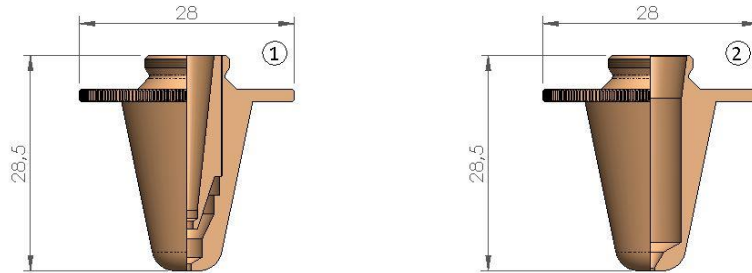

POS	LS. CODE	ORIGINAL CODE	DESCRIPTION	unit price	5 pack price
1	053025		PRECITEC® DOUBLE NOZZLE Ø 1.0		
	053025V		PRECITEC® DOUBLE NOZZLE Ø 1.0		
	053026		PRECITEC® DOUBLE NOZZLE Ø 1.2		
	053026V		PRECITEC® DOUBLE NOZZLE Ø 1.2		
	053027		PRECITEC® DOUBLE NOZZLE Ø 1.5		
	053027V		PRECITEC® DOUBLE NOZZLE Ø 1.5		
	053028		PRECITEC® DOUBLE NOZZLE Ø 1.8		
	053028V		PRECITEC® DOUBLE NOZZLE Ø 1.8		
	053029		PRECITEC® DOUBLE NOZZLE Ø 2.0		
	053029V		PRECITEC® DOUBLE NOZZLE Ø 2.0		
	053030		PRECITEC® DOUBLE NOZZLE Ø 2.3		
	053030V		PRECITEC® DOUBLE NOZZLE Ø 2.3		
	053031		PRECITEC® DOUBLE NOZZLE Ø 2.5		
	053031V		PRECITEC® DOUBLE NOZZLE Ø 2.5		
	053032		PRECITEC® DOUBLE NOZZLE Ø 3.0		
	053032V		PRECITEC® DOUBLE NOZZLE Ø 3.0		
	053033		PRECITEC® DOUBLE NOZZLE Ø 3.5		
	053033V		PRECITEC® DOUBLE NOZZLE Ø 3.5		
2	053037	P0573-563-00010	PRECITEC® NOZZLE Ø 1.0		
	053037V	P0573-563-00010	PRECITEC® NOZZLE Ø 1.0		
	053038	P0573-563-00012	PRECITEC® NOZZLE Ø 1.2		
	053038V	P0573-563-00012	PRECITEC® NOZZLE Ø 1.2		
	053039	P0573-563-00015	PRECITEC® NOZZLE Ø 1.5		
	053039V	P0573-563-00015	PRECITEC® NOZZLE Ø 1.5		
	053040		PRECITEC® NOZZLE Ø 1.8		
	053040V		PRECITEC® NOZZLE Ø 1.8		
	053041	P0573-564-00020	PRECITEC® NOZZLE Ø 2.0		
	053041V	P0573-564-00020	PRECITEC® NOZZLE Ø 2.0		
	053042	P0573-566-00025	PRECITEC® NOZZLE Ø 2.5		
	053042V	P0573-566-00025	PRECITEC® NOZZLE Ø 2.5		
	053043		PRECITEC® NOZZLE Ø 3.0		
	053043V		PRECITEC® NOZZLE Ø 3.0		

San Giorgio Plasma Parts srls is not affiliated with the named manufacturers. Reference to machines, parts, descriptions, and model numbers are for convenience in verifying compatibility only. All parts are made by or for San Giorgio Plasma Parts srls and are not made by the reference manufacturers (unless expressly indicated). All other trademarks are the properties of their respective owners."

Replacement parts suitable for PRECITEC®



POS	LS. CODE	ORIGINAL CODE	DESCRIPTION	unit price	10 pack price
1	052020W		PRECITEC® NOZZLE Ø 1.0 HD		
	052021W		PRECITEC® NOZZLE Ø 1.2 HD		
	052022W		PRECITEC® NOZZLE Ø 1.5 HD		
	052023W		PRECITEC® NOZZLE Ø 2.0 HD		
	052024W		PRECITEC® NOZZLE Ø 2.5 HD		
	052025W		PRECITEC® NOZZLE Ø 3.0 HD		
	052026W		PRECITEC® NOZZLE Ø 3.5 HD		
	052027W		PRECITEC® NOZZLE Ø 4.0 HD		
	052028W		PRECITEC® NOZZLE Ø 4.5 HD		
	052029W		PRECITEC® NOZZLE Ø 5.0 HD		
2	052020CW		PRECITEC® NOZZLE Ø 1.0 HD CP		
	052021CW		PRECITEC® NOZZLE Ø 1.2 HD CP		
	052022CW		PRECITEC® NOZZLE Ø 1.5 HD CP		
	052023CW		PRECITEC® NOZZLE Ø 2.0 HD		
	052024CW		PRECITEC® NOZZLE Ø 2.5 HD CP		
	052025CW		PRECITEC® NOZZLE Ø 3.0 HD CP		
	052026CW		PRECITEC® NOZZLE Ø 3.5 HD CP		
	052027CW		PRECITEC® NOZZLE Ø 4.0 HD CP		
	052028CW		PRECITEC® NOZZLE Ø 4.0 HD CP		
	052029CW		PRECITEC® NOZZLE Ø 5.0 HD CP		

Replacement parts suitable for PRECITEC®



POS	LS. CODE	ORIGINAL CODE	DESCRIPTION	unit price	10 pack price
1	052014W		PRECITEC® NOZZLE Ø 1.5 HD		
	052015W		PRECITEC® NOZZLE Ø 2.0 HD		
	052016W		PRECITEC® NOZZLE Ø 2.5 HD		
2	052014CW		PRECITEC® NOZZLE Ø 1.5 HD CP		
	052015CW		PRECITEC® NOZZLE Ø 2.0 HD CP		
	052016CW		PRECITEC® NOZZLE Ø 2.5 HD CP		

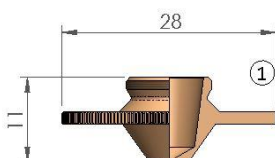

POS	LS. CODE	ORIGINAL CODE	DESCRIPTION	unit price	10 pack price
1	052032W	281340/P0571-281-00010	PRECITEC® NOZZLE Ø 1.0		
	052033W	281341/P0571-282-00012	PRECITEC® NOZZLE Ø 1.2		
	052034W	281342/P0571-283-00015	PRECITEC® NOZZLE Ø 1.5		
	052035W	281342/P0571-284-00018	PRECITEC® NOZZLE Ø 1.8		
	052036W	281343/P0571-285-00020	PRECITEC® NOZZLE Ø 2.0		
	052037W	281344/P0571-286-00025	PRECITEC® NOZZLE Ø 2.5		

Replacement parts suitable for PRECITEC®



POS	LS. CODE	ORIGINAL CODE	DESCRIPTION	unit price	10 pack price
1	052040W	281559/P0571-291-00010	PRECITEC® NOZZLE Ø 1.0		
	052041W	P0571-292-00012	PRECITEC® NOZZLE Ø 1.2		
	052042W	281570/P0571-293-00015	PRECITEC® NOZZLE Ø 1.5		
	052043W		PRECITEC® NOZZLE Ø 1.8		
	052044W	281571/P0571-295-00020	PRECITEC® NOZZLE Ø 2.0		
	052045W	281572/P0571-297-00025	PRECITEC® NOZZLE Ø 2.5		
	052046W		PRECITEC® NOZZLE Ø 3.0		
2	052040CW		PRECITEC® NOZZLE Ø 1.0 CP		
	052041CW		PRECITEC® NOZZLE Ø 1.2 CP		
	052042CW		PRECITEC® NOZZLE Ø 1.5 CP		
	052043CW		PRECITEC® NOZZLE Ø 1.8 CP		
	052044CW		PRECITEC® NOZZLE Ø 2.0 CP		
	052045CW		PRECITEC® NOZZLE Ø 2.5 CP		
	052046CW		PRECITEC® NOZZLE Ø 3.0 CP		

Replacement parts suitable for PRECITEC®



POS	LS. CODE	ORIGINAL CODE	DESCRIPTION	unit price	10 pack price
1	052002W		PRECITEC® DOUBLE NOZZLE Ø 1.0		
	052003W		PRECITEC® DOUBLE NOZZLE Ø 1.2		
	052004W		PRECITEC® DOUBLE NOZZLE Ø 1.4		
	052005W		PRECITEC® DOUBLE NOZZLE Ø 1.5		
	052006W		PRECITEC® DOUBLE NOZZLE Ø 1.8		
	052007W		PRECITEC® DOUBLE NOZZLE Ø 2.0		
	052008W		PRECITEC® DOUBLE NOZZLE Ø 2.5		
	052009W		PRECITEC® DOUBLE NOZZLE Ø 3.0		
	052010W		PRECITEC® DOUBLE NOZZLE Ø 3.5		
	2	052002CW		PRECITEC® DOUBLE NOZZLE Ø 1.0 CP	
052003CW			PRECITEC® DOUBLE NOZZLE Ø 1.2 CP		
052004CW			PRECITEC® DOUBLE NOZZLE Ø 1.4 CP		
052005CW			PRECITEC® DOUBLE NOZZLE Ø 1.5 CP		
052006CW			PRECITEC® DOUBLE NOZZLE Ø 1.8 CP		
052007CW			PRECITEC® DOUBLE NOZZLE Ø 2.0 CP		
052008CW			PRECITEC® DOUBLE NOZZLE Ø 2.5 CP		
052009CW			PRECITEC® DOUBLE NOZZLE Ø 3.0 CP		
052010CW			PRECITEC® DOUBLE NOZZLE Ø 3.5 CP		

Replacement parts suitable for PRECITEC®

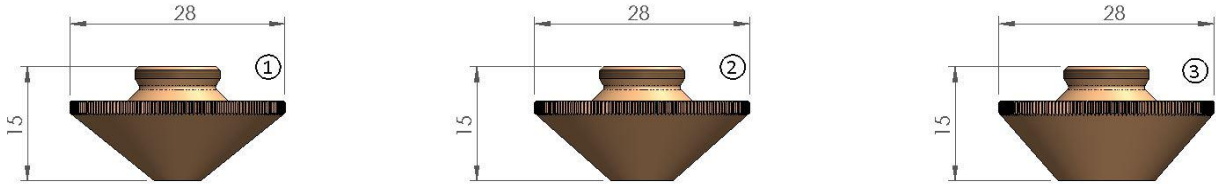

POS	LS. CODE	ORIGINAL CODE	DESCRIPTION	unit price	10 pack price
1	056001		PRECITEC® DOUBLE NOZZLE Ø 2.5 - SS		
	056002		PRECITEC® DOUBLE NOZZLE Ø 3.0 - SS		
	056003		PRECITEC® DOUBLE NOZZLE Ø 4.0 - SS		
2	056004		PRECITEC® DOUBLE NOZZLE Ø 6.0 - SS		
3	056005		PRECITEC® DOUBLE NOZZLE Ø 10.0 - SS		

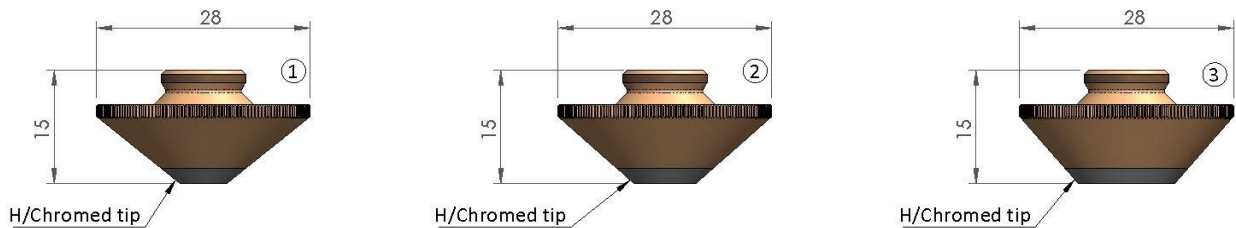

POS	LS. CODE	ORIGINAL CODE	DESCRIPTION	unit price	10 pack price
1	056001CK		PRECITEC® DOUBLE NOZZLE Ø 2.5 CP - SS		
	056002CK		PRECITEC® DOUBLE NOZZLE Ø 3.0 CP - SS		
	056003CK		PRECITEC® DOUBLE NOZZLE Ø 4.0 CP - SS		
2	056004CK		PRECITEC® DOUBLE NOZZLE Ø 6.0 CP - SS		
3	056005CK		PRECITEC® DOUBLE NOZZLE Ø 10.0 CP - SS		

San Giorgio Plasma Parts srls is not affiliated with the named manufacturers. Reference to machines, parts, descriptions, and model numbers are for convenience in verifying compatibility only. All parts are made by or for San Giorgio Plasma Parts srls and are not made by the reference manufacturers (unless expressly indicated). All other trademarks are the properties of their respective owners."

Replacement parts suitable for PRECITEC®

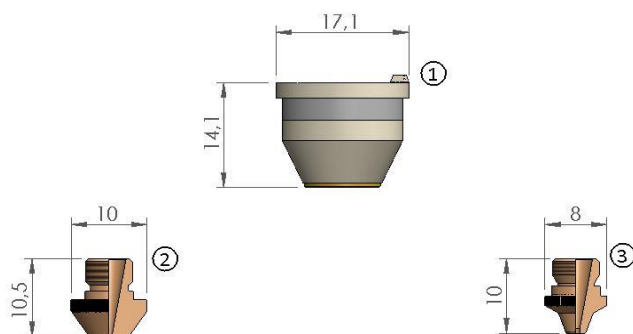

POS	LS. CODE	ORIGINAL CODE	DESCRIPTION	unit price	10 pack price
1	059010	280408- P0494-752-00001-092405	PRECITEC® ORIGINAL NOZZLE HOLDER KT M1,5" KN		
2	054002W		PRECITEC® NOZZLE Ø 0.8		
	054003W	280551-P0494-853-00010	PRECITEC® NOZZLE Ø 1.0		
	054004W	280552-P0494-854-00012	PRECITEC® NOZZLE Ø 1.2		
	054005W	280553-P0494-855-00015	PRECITEC® NOZZLE Ø 1.5		
	054006W	280554-P0494-856-00017	PRECITEC® NOZZLE Ø 1.7		
	054007W	280555-èP0494-857-00020	PRECITEC® NOZZLE Ø 2.0		
	054008W		PRECITEC® NOZZLE Ø 2.3		
	054009W		PRECITEC® NOZZLE Ø 2.5		
	054010W		PRECITEC® NOZZLE Ø 3.0		
	054011W		PRECITEC® NOZZLE Ø 4.0		
3	054016W	280943-P0494-787-00010	PRECITEC® NOZZLE Ø 1.0		
	054017W	280942-P0494-788-00012	PRECITEC® NOZZLE Ø 1.2		
	054018W	280941-P0494-789-00015	PRECITEC® NOZZLE Ø 1.5		
	054019W		PRECITEC® NOZZLE Ø 1.8		
	054020W		PRECITEC® NOZZLE Ø 2.0		

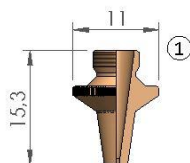

POS	LS. CODE	ORIGINAL CODE	DESCRIPTION	unit price	10 pack price
1	054025W		PRECITEC® NOZZLE Ø 1.0		
	054026W	P0787-483-00012	PRECITEC® NOZZLE Ø 1.2		
	054027W	P0787-483-00015	PRECITEC® NOZZLE Ø 1.5		
	054028W		PRECITEC® NOZZLE Ø 1.7		
	054029W	P0787-1001-00020	PRECITEC® NOZZLE Ø 2.0		
	054030W		PRECITEC® NOZZLE Ø 2.5		

San Giorgio Plasma Parts srls is not affiliated with the named manufacturers. Reference to machines, parts, descriptions, and model numbers are for convenience in verifying compatibility only. All parts are made by or for San Giorgio Plasma Parts srls and are not made by the reference manufacturers (unless expressly indicated). All other trademarks are the properties of their respective owners."

Replacement parts suitable for PRECITEC®

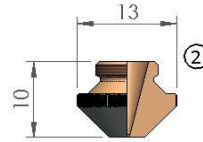
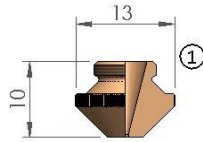

POS	LS. CODE	ORIGINAL CODE	DESCRIPTION	unit price	10 pack price
1	055020W	280013, P0492-441-00008, W222	PRECITEC® NOZZLE Ø 0.8		
	055021W	280014, P0492-442-00010, W223	PRECITEC® NOZZLE Ø 1.0		
	055022W	280015, P0492-443-00012, W228	PRECITEC® NOZZLE Ø 1.2		
	055023W	280016, P0492-444-00015, W224	PRECITEC® NOZZLE Ø 1.5		
	055024W	P0492-447-00018	PRECITEC® NOZZLE Ø 1.8		
	055025W	280937, P0492-445-00020, W225	PRECITEC® NOZZLE Ø 2.0		
	055026W	P0492-448-00023	PRECITEC® NOZZLE Ø 2.3		
	055027W	281791, P0492-446-00025, W226	PRECITEC® NOZZLE Ø 2,5		
	055028W		PRECITEC® NOZZLE Ø 3.0		
2	055020CW	280013, P0492-441-00008, W222	PRECITEC® NOZZLE Ø 0.8 CP		
	055021CW	280014, P0492-442-00010, W223	PRECITEC® NOZZLE Ø 1.0 CP		
	055022CW	280015, P0492-443-00012, W228	PRECITEC® NOZZLE Ø 1.2 CP		
	055023CW	280016, P0492-444-00015, W224	PRECITEC® NOZZLE Ø 1.5 CP		
	055024CW	P0492-447-00018	PRECITEC® NOZZLE Ø 1.8 CP		
	055025CW	280937, P0492-445-00020, W225	PRECITEC® NOZZLE Ø 2.0 CP		
	055026CW	P0492-448-00023	PRECITEC® NOZZLE Ø 2.3 CP		
	055027CW	281791, P0492-446-00025, W226	PRECITEC® NOZZLE Ø 2,5 CP		
	055028CW		PRECITEC® NOZZLE Ø 3.0 CP		

Replacement parts suitable for PRECITEC®

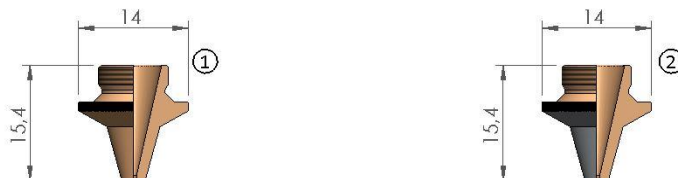

POS	LS. CODE	ORIGINAL CODE	DESCRIPTION	unit price	10 pack price
1	055014W	281813, P0589-424-00008	PRECITEC® NOZZLE Ø 0.8		
	055015W	281789, P0589-426-00010	PRECITEC® NOZZLE Ø 1.0		
	055016W	281561, 778550	PRECITEC® NOZZLE Ø 1.2		
	055017W	281814, 149957	PRECITEC® NOZZLE Ø 1.5		
	055018W	P0589-428-00020	PRECITEC® NOZZLE Ø 2.0		
2	055014CW	281813, P0589-424-00008	PRECITEC® NOZZLE Ø 0.8 CP		
	055015CW	281789, P0589-426-00010	PRECITEC® NOZZLE Ø 1.0 CP		
	055016CW	281561, 778550	PRECITEC® NOZZLE Ø 1.2 CP		
	055017CW	281814, 149957	PRECITEC® NOZZLE Ø 1.5 CP		
	055018CW	P0589-428-00020	PRECITEC® NOZZLE Ø 2.0 CP		

POS	LS. CODE	ORIGINAL CODE	DESCRIPTION	unit price	10 pack price
	059030	P0360-240-20000	PRECITEC® ORIGINAL SENSOR CABLE KS 20M GW Z PU		
	059031	P0360-210-00600	PRECITEC® ELECTRODE CABLE 600MM GW		
	059032	P0360-600-00320	PRECITEC® ORIGINAL CABLE KE 320 gg		
	059033	P0360-100-00500	PRECITEC® ORIGINAL ELECTRODE CABLE 500MM GG Z		
	059034	P0360-156-00200	PRECITEC® ORIGINAL SENSOR CABLE 200MM		
	059035	P0492-001-00130	PRECITEC® ORIGINAL SENSOR CABLE KE 130 GW		

San Giorgio Plasma Parts srls is not affiliated with the named manufacturers. Reference to machines, parts, descriptions, and model numbers are for convenience in verifying compatibility only. All parts are made by or for San Giorgio Plasma Parts srls and are not made by the reference manufacturers (unless expressly indicated). All other trademarks are the properties of their respective owners."