

Replacement parts suitable for CUTLITE PENTA®

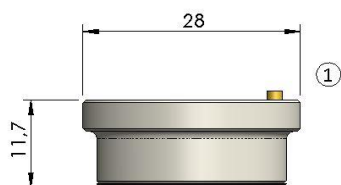

POS	LS. CODE	ORIGINAL CODE	DESCRIPTION	unit price	10 pack price
1	059003	P0571-1051-00001, 6930281333-080800302	PRECITEC® NOZZLE HOLDER KT B2" CON		

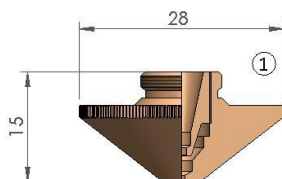

POS	LS. CODE	ORIGINAL CODE	DESCRIPTION	unit price	10 pack price
1	071001	10.03.11.09.001-080800221	PENTA® DOUBLE NOZZLE Ø 1.0		
	071001W	10.03.11.09.001-080800221	PENTA® DOUBLE NOZZLE Ø 1.0		
	071002	10.03.11.09.002-080800222	PENTA® DOUBLE NOZZLE Ø 1.25		
	071002W	10.03.11.09.002-080800222	PENTA® DOUBLE NOZZLE Ø 1.25		
	071003	10.03.11.09.003-080800223	PENTA® DOUBLE NOZZLE Ø 1.5		
	071003W	10.03.11.09.003-080800223	PENTA® DOUBLE NOZZLE Ø 1.5		
	071004	10.03.11.09.005-080800225	PENTA® DOUBLE NOZZLE Ø 2.0		
	071004W	10.03.11.09.005-080800225	PENTA® DOUBLE NOZZLE Ø 2.0		
	071005	10.03.11.09.006-080800226	PENTA® DOUBLE NOZZLE Ø 2.5		
	071005W	10.03.11.09.006-080800226	PENTA® DOUBLE NOZZLE Ø 2.5		
	071006	10.03.11.09.007-080800227	PENTA® DOUBLE NOZZLE Ø 3.0		
	071006W	10.03.11.09.007-080800227	PENTA® DOUBLE NOZZLE Ø 3.0		
	071007	10.03.11.09.008-080800228	PENTA® DOUBLE NOZZLE Ø 3.5		
	071007W	10.03.11.09.008-080800228	PENTA® DOUBLE NOZZLE Ø 3.5		
	071008	10.03.11.09.021-080800229	PENTA® DOUBLE NOZZLE Ø 4.0		
	071008W	10.03.11.09.021-080800229	PENTA® DOUBLE NOZZLE Ø 4.0		
	071009	10.03.11.09.022-080800216	PENTA® DOUBLE NOZZLE Ø 4.5		
071009W	10.03.11.09.022-080800216	PENTA® DOUBLE NOZZLE Ø 4.5			

San Giorgio Plasma Parts srls is not affiliated with the named manufacturers. Reference to machines, parts, descriptions, and model numbers are for convenience in verifying compatibility only. All parts are made by or for San Giorgio Plasma Parts srls and are not made by the reference manufactures (unless expressly indicated). All other trademarks are the properties of their respective owners."

Replacement parts suitable for CUTLITE PENTA®

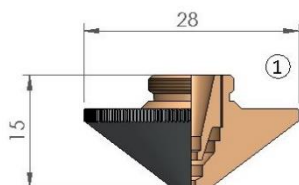

POS	LS. CODE	ORIGINAL CODE	DESCRIPTION	unit price	10 pack price
1	071001C		PENTA® DOUBLE NOZZLE Ø 1.0 CP		
	071001CW		PENTA® DOUBLE NOZZLE Ø 1.0 CP		
	071002C		PENTA® DOUBLE NOZZLE Ø 1.25 CP		
	071002CW		PENTA® DOUBLE NOZZLE Ø 1.25 CP		
	071003C		PENTA® DOUBLE NOZZLE Ø 1.5 CP		
	071003CW		PENTA® DOUBLE NOZZLE Ø 1.5 CP		
	071004C		PENTA® DOUBLE NOZZLE Ø 2.0 CP		
	071004CW		PENTA® DOUBLE NOZZLE Ø 2.0 CP		
	071005C		PENTA® DOUBLE NOZZLE Ø 2.5 CP		
	071005CW		PENTA® DOUBLE NOZZLE Ø 2.5 CP		
	071006C		PENTA® DOUBLE NOZZLE Ø 3.0 CP		
	071006CW		PENTA® DOUBLE NOZZLE Ø 3.0 CP		
	071007C		PENTA® DOUBLE NOZZLE Ø 3.5 CP		
	071007CW		PENTA® DOUBLE NOZZLE Ø 3.5 CP		
	071008C		PENTA® DOUBLE NOZZLE Ø 4.0 CP		
	071008CW		PENTA® DOUBLE NOZZLE Ø 4.0 CP		
	071009C		PENTA® DOUBLE NOZZLE Ø 4.5 CP		
	071009CW		PENTA® DOUBLE NOZZLE Ø 4.5 CP		

Replacement parts suitable for CUTLITE PENTA®

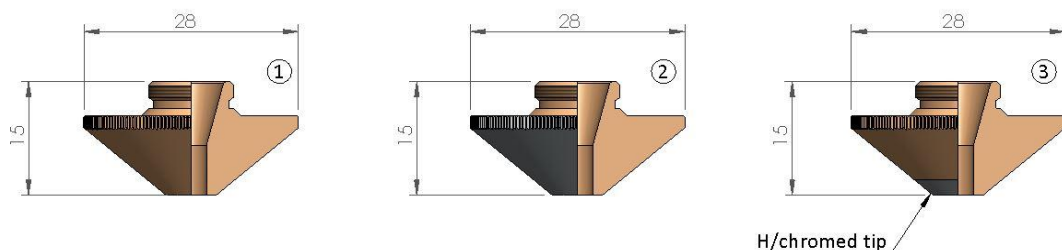

POS	LS. CODE	ORIGINAL CODE	DESCRIPTION	unit price	10 pack price
1	071025W	10.03.11.09.015-080800235	PENTA® NOZZLE Ø 4.0 HD LARGE HEAD		
	071026W	10.03.11.09.016-080800236	PENTA® NOZZLE Ø 4.5 HD LARGE HEAD		
	071027W	10.03.11.09.030-080800237	PENTA® NOZZLE Ø 5.0 HD LARGE HEAD		
2	071025C		PENTA® NOZZLE Ø 4.0 HD LARGE HEAD CP		
	071025CW		PENTA® NOZZLE Ø 4.0 HD LARGE HEAD CP		
	071026C		PENTA® NOZZLE Ø 4.5 HD LARGE HEAD CP		
	071026CW		PENTA® NOZZLE Ø 4.5 HD LARGE HEAD CP		
	071027C		PENTA® NOZZLE Ø 5.0 HD LARGE HEAD CP		
	071027CW		PENTA® NOZZLE Ø 5.0 HD LARGE HEAD CP		
3	071025CKW		PENTA® NOZZLE Ø 4.0 HD LARGE HEAD CP		
	071026CKW		PENTA® NOZZLE Ø 4.5 HD LARGE HEAD CP		
	071027CKW		PENTA® NOZZLE Ø 5.0 HD LARGE HEAD CP		

Replacement parts suitable for CUTLITE PENTA®

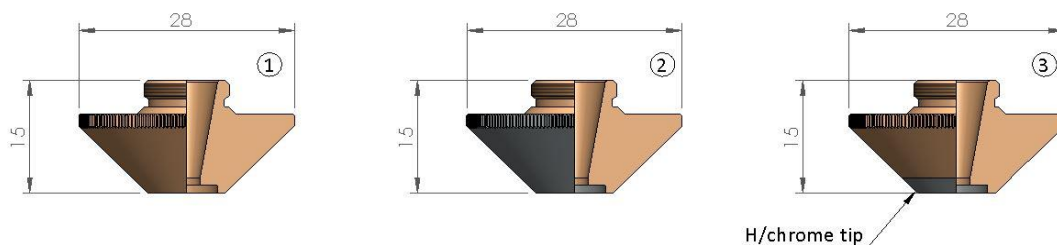

POS	LS. CODE	ORIGINAL CODE	DESCRIPTION	unit price	10 pack price
1	071030W	10.03.11.05.083 080800219	PENTA® NOZZLE Ø 3.5 BOOSTER CUT		
	071033W	10.03.11.05.084 080800220	PENTA® NOZZLE Ø 5.0 BOOSTER CUT		
	071034W	080800218	PENTA® NOZZLE Ø 6.0 BOOSTER CUT		
	071035W		PENTA® NOZZLE Ø 7.0 BOOSTER CUT		
2	071030CW		PENTA® NOZZLE Ø 3.5 BOOSTER CUT CP		
	071033CW		PENTA® NOZZLE Ø 5.0 BOOSTER CUT CP		
	071034CW		PENTA® NOZZLE Ø 6.0 BOOSTER CUT CP		
	071035CW		PENTA® NOZZLE Ø 7.0 BOOSTER CUT CP		
3	071030CKW		PENTA® NOZZLE Ø 3.5 BOOSTER CUT CP		
	071033CKW		PENTA® NOZZLE Ø 5.0 BOOSTER CUT CP		
	071034CKW		PENTA® NOZZLE Ø 6.0 BOOSTER CUT CP		
	071035CKW		PENTA® NOZZLE Ø 7.0 BOOSTER CUT CP		



POS	LS. CODE	ORIGINAL CODE	DESCRIPTION	unit price	10 pack price
	072002W	10.03.11.11.004	PENTA® DOUBLE NOZZLE Ø 5.0 HQ		
	072002CW	10.03.11.11.004	PENTA® DOUBLE NOZZLE Ø 5.0 HQ CP		

San Giorgio Plasma Parts srls is not affiliated with the named manufacturers. Reference to machines, parts, descriptions, and model numbers are for convenience in verifying compatibility only. All parts are made by or for San Giorgio Plasma Parts srls and are not made by the reference manufactures (unless expressly indicated). All other trademarks are the properties of their respective owners."

Replacement parts suitable for CUTLITE PENTA®

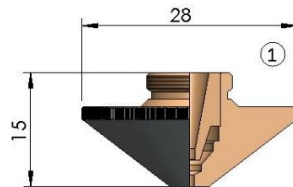

POS	LS. CODE	ORIGINAL CODE	DESCRIPTION	unit price	10 pack price
1	071012C	080800245	PENTA® DOUBLE NOZZLE Ø 1.2 CP		
	071012CW	080800245	PENTA® DOUBLE NOZZLE Ø 1.2 CP		
	071013C	080800246	PENTA® DOUBLE NOZZLE Ø 1.4 CP		
	071013CW	080800246	PENTA® DOUBLE NOZZLE Ø 1.4 CP		
	071014C	080800247	PENTA® DOUBLE NOZZLE Ø 1.6 CP		
	071014CW	080800247	PENTA® DOUBLE NOZZLE Ø 1.6 CP		
	071015C	080800248	PENTA® DOUBLE NOZZLE Ø 1.8 CP		
	071015CW	080800248	PENTA® DOUBLE NOZZLE Ø 1.8 CP		
	071016C	080800249	PENTA® DOUBLE NOZZLE Ø 2.0 CP		
	071016CW	080800249	PENTA® DOUBLE NOZZLE Ø 2.0 CP		

Replacement parts suitable for CUTLITE PENTA®

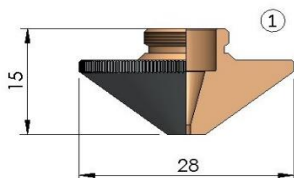

POS	LS. CODE	ORIGINAL CODE	DESCRIPTION	unit price	10 pack price
1	071041C	080800304	PENTA® NOZZLE Ø 1.0 CP		
	071041CW	080800304	PENTA® NOZZLE Ø 1.0 CP		
	071042C	080800305	PENTA® NOZZLE Ø 1.25 CP		
	071042CW	080800305	PENTA® NOZZLE Ø 1.25 CP		
	071043C	080800306	PENTA® NOZZLE Ø 1.4 CP		
	071043CW	080800306	PENTA® NOZZLE Ø 1.4 CP		
	071044C	080800307	PENTA® NOZZLE Ø 1.5 CP		
	071044CW	080800307	PENTA® NOZZLE Ø 1.5 CP		
	071045C	080800308	PENTA® NOZZLE Ø 1.6 CP		
	071045CW	080800308	PENTA® NOZZLE Ø 1.6 CP		
	071046C	080800309	PENTA® NOZZLE Ø 1.7 CP		
	071046CW	080800309	PENTA® NOZZLE Ø 1.7 CP		
	071047C	080800310	PENTA® NOZZLE Ø 1.8 CP		
	071047CW	080800310	PENTA® NOZZLE Ø 1.8 CP		
	071148C		PENTA® NOZZLE Ø 2.1 CP		
	071148CW		PENTA® NOZZLE Ø 2.1 CP		
	071149C		PENTA® NOZZLE Ø 2.2 CP		
	071149CW		PENTA® NOZZLE Ø 2.2 CP		
	071150C		PENTA® NOZZLE Ø 2.3 CP		
	071150CW		PENTA® NOZZLE Ø 2.3 CP		
071151C		PENTA® NOZZLE Ø 2.4 CP			
071151CW		PENTA® NOZZLE Ø 2.4 CP			

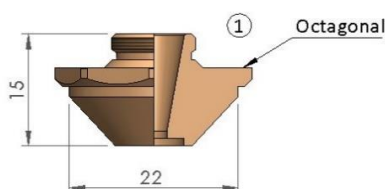

POS	LS. CODE	ORIGINAL CODE	DESCRIPTION	unit price	10 pack price
1	071036	080800296	PENTA® NOZZLE Ø 3.5 BOOSTER CUT		
	071036W	080800296	PENTA® NOZZLE Ø 3.5 BOOSTER CUT		
	071039	080800349	PENTA® NOZZLE Ø 5.0 BOOSTER CUT		
	071039W	080800349	PENTA® NOZZLE Ø 5.0 BOOSTER CUT		
	071040	080800385	PENTA® NOZZLE Ø 6.0 BOOSTER CUT		
	071040W	080800385	PENTA® NOZZLE Ø 6.0 BOOSTER CUT		

San Giorgio Plasma Parts srls is not affiliated with the named manufacturers. Reference to machines, parts, descriptions, and model numbers are for convenience in verifying compatibility only. All parts are made by or for San Giorgio Plasma Parts srls and are not made by the reference manufactures (unless expressly indicated). All other trademarks are the properties of their respective owners."

Replacement parts suitable for CUTLITE PENTA®

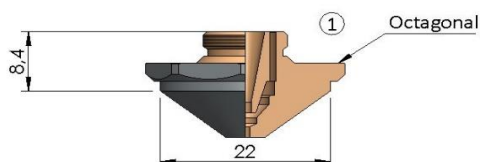

POS	LS. CODE	ORIGINAL CODE	DESCRIPTION	unit price	10 pack price
1	071018C	080800297	PENTA® DOUBLE NOZZLE Ø 1.2 CP		
	071018CW	080800297	PENTA® DOUBLE NOZZLE Ø 1.2 CP		
	071019C	080800298	PENTA® DOUBLE NOZZLE Ø 1.4 CP		
	071019CW	080800298	PENTA® DOUBLE NOZZLE Ø 1.4 CP		
	071020C	080800299	PENTA® DOUBLE NOZZLE Ø 1.6 CP		
	071020CW	080800299	PENTA® DOUBLE NOZZLE Ø 1.6 CP		
	071021C	080800300	PENTA® DOUBLE NOZZLE Ø 1.8 CP		
	071021CW	080800300	PENTA® DOUBLE NOZZLE Ø 1.8 CP		
	071022C		PENTA® DOUBLE NOZZLE Ø 2.0 CP		
	071022CW		PENTA® DOUBLE NOZZLE Ø 2.0 CP		

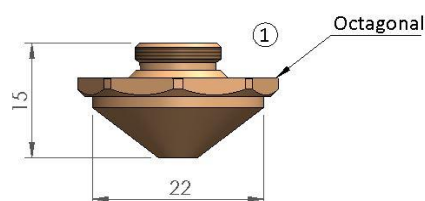

POS	LS. CODE	ORIGINAL CODE	DESCRIPTION	unit price	10 pack price
1	071051	080800347	PENTA® DUOBLE NOZZLE Ø 1.0		
	071051W	080800347	PENTA® DUOBLE NOZZLE Ø 1.0		
	071052	080800348	PENTA® DUOBLE NOZZLE Ø 1.25		
	071052W	080800348	PENTA® DUOBLE NOZZLE Ø 1.25		
	071053	080800375	PENTA® DUOBLE NOZZLE Ø 1.5		
	071053W	080800375	PENTA® DUOBLE NOZZLE Ø 1.5		
	071054	080800376	PENTA® DUOBLE NOZZLE Ø 2.0		
	071054W	080800376	PENTA® DUOBLE NOZZLE Ø 2.0		
	071055	080800350	PENTA® DUOBLE NOZZLE Ø 2.5		
	071055W	080800350	PENTA® DUOBLE NOZZLE Ø 2.5		
	071056	080800351	PENTA® DUOBLE NOZZLE Ø 3.0		
	071056W	080800351	PENTA® DUOBLE NOZZLE Ø 3.0		
	071057	080800352	PENTA® DUOBLE NOZZLE Ø 3.5		
	071057W	080800352	PENTA® DUOBLE NOZZLE Ø 3.5		
	071058	080800353	PENTA® DUOBLE NOZZLE Ø 4.0		
	071058W	080800353	PENTA® DUOBLE NOZZLE Ø 4.0		
	071059	080800377	PENTA® DUOBLE NOZZLE Ø 4.5		
	071059W	080800377	PENTA® DUOBLE NOZZLE Ø 4.5		
	071060	080800378	PENTA® DUOBLE NOZZLE Ø 5.0		
	071060W	080800378	PENTA® DUOBLE NOZZLE Ø 5.0		

San Giorgio Plasma Parts srls is not affiliated with the named manufacturers. Reference to machines, parts, descriptions, and model numbers are for convenience in verifying compatibility only. All parts are made by or for San Giorgio Plasma Parts srls and are not made by the reference manufactures (unless expressly indicated). All other trademarks are the properties of their respective owners."

Replacement parts suitable for CUTLITE PENTA®

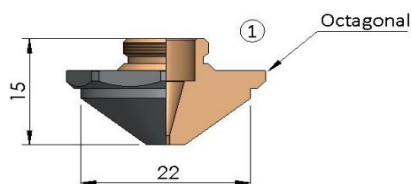

POS	LS. CODE	ORIGINAL CODE	DESCRIPTION	unit price	10 pack price
1	071081C		PENTA® NOZZLE Ø 1.0 CP		
	071081CW		PENTA® NOZZLE Ø 1.0 CP		
	071082C	080800379	PENTA® NOZZLE Ø 1.25 CP		
	071082CW	080800379	PENTA® NOZZLE Ø 1.25 CP		
	071083C	080800380	PENTA® NOZZLE Ø 1.4 CP		
	071083CW	080800380	PENTA® NOZZLE Ø 1.4 CP		
	071084C		PENTA® NOZZLE Ø 1.5 CP		
	071084CW		PENTA® NOZZLE Ø 1.5 CP		
	071085C	080800381	PENTA® NOZZLE Ø 1.6 CP		
	071085CW	080800381	PENTA® NOZZLE Ø 1.6 CP		
	071086C		PENTA® NOZZLE Ø 1.7 CP		
	071086CW		PENTA® NOZZLE Ø 1.7 CP		
	071087C	080800382	PENTA® NOZZLE Ø 1.8 CP		
	071087CW	080800382	PENTA® NOZZLE Ø 1.8 CP		

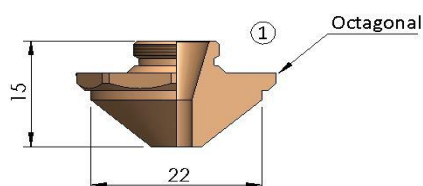

POS	LS. CODE	ORIGINAL CODE	DESCRIPTION	unit price	10 pack price
1	071091	080800372	PENTA® NOZZLE Ø 4.0		
	071091W	080800372	PENTA® NOZZLE Ø 4.0		
	071092	080800373	PENTA® NOZZLE Ø 4.5		
	071092W	080800373	PENTA® NOZZLE Ø 4.5		
	071093	080800374	PENTA® NOZZLE Ø 5.0		
	071093W	080800374	PENTA® NOZZLE Ø 5.0		

San Giorgio Plasma Parts srls is not affiliated with the named manufacturers. Reference to machines, parts, descriptions, and model numbers are for convenience in verifying compatibility only. All parts are made by or for San Giorgio Plasma Parts srls and are not made by the reference manufactures (unless expressly indicated). All other trademarks are the properties of their respective owners."

Replacement parts suitable for CUTLITE PENTA®

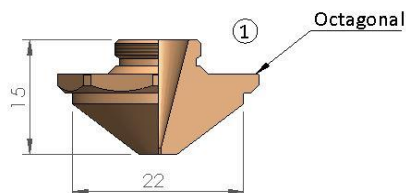

POS	LS. CODE	ORIGINAL CODE	DESCRIPTION	unit price	10 pack price
1	071063		PENTA® NOZZLE Ø 0.8 HD		
	071063W		PENTA® NOZZLE Ø 0.8 HD		
	071064		PENTA® NOZZLE Ø 1.0 HD		
	071064W		PENTA® NOZZLE Ø 1.0 HD		
	071065		PENTA® NOZZLE Ø 1.2 HD		
	071065W		PENTA® NOZZLE Ø 1.2 HD		
	071066		PENTA® NOZZLE Ø 1.4 HD		
	071066W		PENTA® NOZZLE Ø 1.4 HD		
	071067	080800369	PENTA® NOZZLE Ø 1.5 HD		
	071067W	080800369	PENTA® NOZZLE Ø 1.5 HD		
	071068		PENTA® NOZZLE Ø 1.8 HD		
	071068W		PENTA® NOZZLE Ø 1.8 HD		
	071069	080800301	PENTA® NOZZLE Ø 2.0 HD		
	071069W	080800301	PENTA® NOZZLE Ø 2.0 HD		
	071070		PENTA® NOZZLE Ø 2.3 HD		
	071070W		PENTA® NOZZLE Ø 2.3 HD		
	071071	080800354	PENTA® NOZZLE Ø 2.5 HD		
	071071W	080800354	PENTA® NOZZLE Ø 2.5 HD		
	071072		PENTA® NOZZLE Ø 2.75 HD		
	071072W		PENTA® NOZZLE Ø 2.75 HD		
	071073	080800370	PENTA® NOZZLE Ø 3.0 HD		
	071073W	080800370	PENTA® NOZZLE Ø 3.0 HD		
	071074		PENTA® NOZZLE Ø 3.2 HD		
	071074W		PENTA® NOZZLE Ø 3.2 HD		
	071075	080800371	PENTA® NOZZLE Ø 3.5 HD		
	071075W	080800371	PENTA® NOZZLE Ø 3.5 HD		
	071076		PENTA® NOZZLE Ø 4.0 HD		
	071076W		PENTA® NOZZLE Ø 4.0 HD		
	071077		PENTA® NOZZLE Ø 4.5 HD		
	071077W		PENTA® NOZZLE Ø 4.5 HD		
071078		PENTA® NOZZLE Ø 5.0 HD			
071078W		PENTA® NOZZLE Ø 5.0 HD			

San Giorgio Plasma Parts srls is not affiliated with the named manufacturers. Reference to machines, parts, descriptions, and model numbers are for convenience in verifying compatibility only. All parts are made by or for San Giorgio Plasma Parts srls and are not made by the reference manufactures (unless expressly indicated). All other trademarks are the properties of their respective owners."

Replacement parts suitable for CUTLITE PENTA®

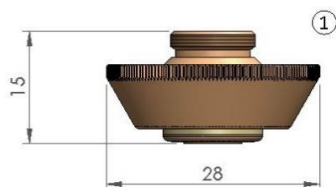

POS	LS. CODE	ORIGINAL CODE	DESCRIPTION	unit price	10 pack price
1	072010	080800356	PENTA® TOUCHDOWN NOZZLE		

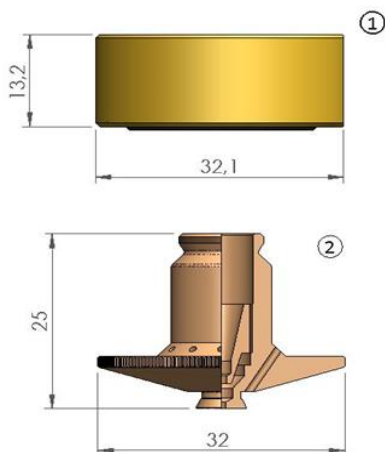

POS	LS. CODE	ORIGINAL CODE	DESCRIPTION	unit price	10 pack price
1	079001	T10LO096B-080800265	PENTA® ADAPTER COOLTECH V2		
2	073003		PENTA® DOUBLE NOZZLE Ø 1.0		
	073004	080800254	PENTA® DOUBLE NOZZLE Ø 1.2		
	073010	080800255	PENTA® DOUBLE NOZZLE Ø 2.5		
	073012	080800256	PENTA® DOUBLE NOZZLE Ø 3.0		
	073013	080800257	PENTA® DOUBLE NOZZLE Ø 3.5		
	073014	080800258	PENTA® DOUBLE NOZZLE Ø 4.0		
	073015	080800259	PENTA® DOUBLE NOZZLE Ø 4.5		

Replacement parts suitable for CUTLITE PENTA®

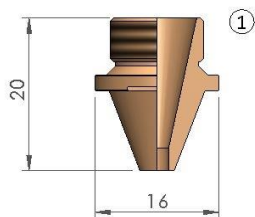

POS	LS. CODE	ORIGINAL CODE	DESCRIPTION	unit price	10 pack price
	074004W	080800303	PENTA® NOZZLE Ø 2.0		
	074006W	080800273	PENTA® NOZZLE Ø 3.0		
	074008W	080800274	PENTA® NOZZLE Ø 4.0		
	074010W	080800275	PENTA® NOZZLE Ø 5.0		

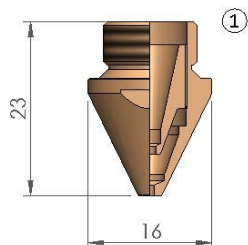

POS	LS. CODE	ORIGINAL CODE	DESCRIPTION	unit price	10 pack price
	074013W	080800276	PENTA® DOUBLE NOZZLE Ø 1.2		
	074014W	080800277	PENTA® DOUBLE NOZZLE Ø 1.4		
	074015W	080800278	PENTA® DOUBLE NOZZLE Ø 1.6		
	074016W	080800279	PENTA® DOUBLE NOZZLE Ø 2.0		
	074017W	080800280	PENTA® DOUBLE NOZZLE Ø 2.5		
	074018W	080800281	PENTA® DOUBLE NOZZLE Ø 3.0		
	074019W	080800282	PENTA® DOUBLE NOZZLE Ø 3.5		
	074020W	080800283	PENTA® DOUBLE NOZZLE Ø 4.0		

Replacement parts suitable for CUTLITE PENTA®



POS	LS. CODE	ORIGINAL CODE	DESCRIPTION	unit price	10 pack price
1	074031CW		PENTA® NOZZLE Ø 1.0 CP		
	074032CW		PENTA® NOZZLE Ø 1.25 CP		
	074033CW		PENTA® NOZZLE Ø 1.4 CP		
	074034CW		PENTA® NOZZLE Ø 1.5 CP		
	074035CW		PENTA® NOZZLE Ø 1.6 CP		
	074036CW		PENTA® NOZZLE Ø 1.7 CP		
	074037CW		PENTA® NOZZLE Ø 1.8 CP		
2	074031CKW		PENTA® NOZZLE Ø 1.0 CP		
	074032CKW		PENTA® NOZZLE Ø 1.25 CP		
	074033CKW		PENTA® NOZZLE Ø 1.4 CP		
	074034CKW		PENTA® NOZZLE Ø 1.5 CP		
	074035CKW		PENTA® NOZZLE Ø 1.6 CP		
	074036CKW		PENTA® NOZZLE Ø 1.7 CP		
	074037CKW		PENTA® NOZZLE Ø 1.8 CP		

Replacement parts suitable for CUTLITE PENTA®

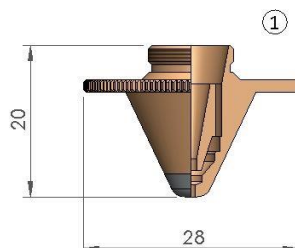

POS	LS. CODE	ORIGINAL CODE	DESCRIPTION	unit price	5 pack price
1	074024CK	074024	PENTA® DOUBLE NOZZLE Ø 1.2 CP		
	074024CKV		PENTA® DOUBLE NOZZLE Ø 1.2 CP		
	074025CK		PENTA® DOUBLE NOZZLE Ø 1.4 CP		
	074025CKV		PENTA® DOUBLE NOZZLE Ø 1.4 CP		
	074026CK		PENTA® DOUBLE NOZZLE Ø 1.6 CP		
	074026CKV		PENTA® DOUBLE NOZZLE Ø 1.6 CP		
	074027CK		PENTA® DOUBLE NOZZLE Ø 1.8 CP		
	074027CKV		PENTA® DOUBLE NOZZLE Ø 1.8 CP		
	074028CK		PENTA® DOUBLE NOZZLE Ø 2.0 CP		
	074028CKV		PENTA® DOUBLE NOZZLE Ø 2.0 CP		

Replacement parts suitable for CUTLITE PENTA®

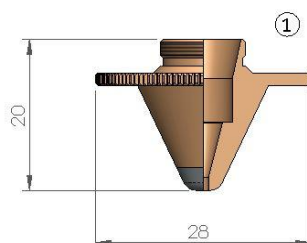

POS	LS. CODE	ORIGINAL CODE	DESCRIPTION	unit price	5 pack price
1	074043CK	074043	PENTA® NOZZLE Ø 1.4 CP		
	074043CKV		PENTA® NOZZLE Ø 1.4 CP		
	074044CK		PENTA® NOZZLE Ø 1.5 CP		
	074044CKV		PENTA® NOZZLE Ø 1.5 CP		
	074045CK		PENTA® NOZZLE Ø 1.6 CP		
	074045CKV		PENTA® NOZZLE Ø 1.6 CP		

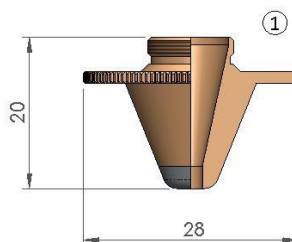

POS	LS. CODE	ORIGINAL CODE	DESCRIPTION	unit price	5 pack price
1	074055CK		PENTA® NOZZLE Ø 3.0 CP		
	074055CKV		PENTA® NOZZLE Ø 3.0 CP		
	074057CK		PENTA® NOZZLE Ø 4.0 CP		
	074057CKV		PENTA® NOZZLE Ø 4.0 CP		
	074059CK	074059CK	PENTA® NOZZLE Ø 5.0 CP		
	074059CKV		PENTA® NOZZLE Ø 5.0 CP		

San Giorgio Plasma Parts srls is not affiliated with the named manufacturers. Reference to machines, parts, descriptions, and model numbers are for convenience in verifying compatibility only. All parts are made by or for San Giorgio Plasma Parts srls and are not made by the reference manufactures (unless expressly indicated). All other trademarks are the properties of their respective owners."

Replacement parts suitable for CUTLITE PENTA®

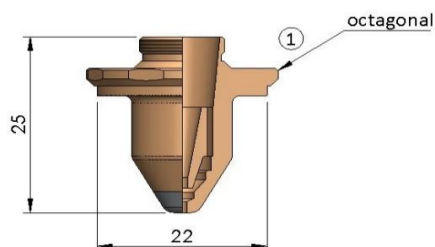

POS	LS. CODE	ORIGINAL CODE	DESCRIPTION	unit price	5 pack price
1	074064CK	080800361	PENTA® DOUBLE NOZZLE Ø 1.2 CP		
	074064CKV	080800361	PENTA® DOUBLE NOZZLE Ø 1.2 CP		
	074065CK	080800362	PENTA® DOUBLE NOZZLE Ø 1.4 CP		
	074065CKV	080800362	PENTA® DOUBLE NOZZLE Ø 1.4 CP		
	074066CK	080800363	PENTA® DOUBLE NOZZLE Ø 1.6 CP		
	074066CKV	080800363	PENTA® DOUBLE NOZZLE Ø 1.6 CP		
	074067CK	080800364	PENTA® DOUBLE NOZZLE Ø 1.8 CP		
	074067CKV	080800364	PENTA® DOUBLE NOZZLE Ø 1.8 CP		
	074068CK		PENTA® DOUBLE NOZZLE Ø 2.0 CP		
	074068CKV		PENTA® DOUBLE NOZZLE Ø 2.0 CP		

San Giorgio Plasma Parts srls is not affiliated with the named manufacturers. Reference to machines, parts, descriptions, and model numbers are for convenience in verifying compatibility only. All parts are made by or for San Giorgio Plasma Parts srls and are not made by the reference manufactures (unless expressly indicated). All other trademarks are the properties of their respective owners."

Replacement parts suitable for CUTLITE PENTA®

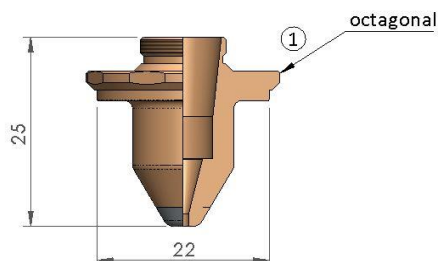

POS	LS. CODE	ORIGINAL CODE	DESCRIPTION	unit price	5 pack price
1	074071CK		PENTA® NOZZLE Ø 1.0 CP		
	074071CKV		PENTA® NOZZLE Ø 1.0 CP		
	074072CK		PENTA® NOZZLE Ø 1.2 CP		
	074072CKV		PENTA® NOZZLE Ø 1.2 CP		
	074073CK	080800358	PENTA® NOZZLE Ø 1.4 CP		
	074073CKV	080800358	PENTA® NOZZLE Ø 1.4 CP		
	074074CK		PENTA® NOZZLE Ø 1.5 CP		
	074074CKV		PENTA® NOZZLE Ø 1.5 CP		
	074075CK	080800359	PENTA® NOZZLE Ø 1.6 CP		
	074075CKV	080800359	PENTA® NOZZLE Ø 1.6 CP		
	074076CK		PENTA® NOZZLE Ø 1.7 CP		
	074076CKV		PENTA® NOZZLE Ø 1.7 CP		
	074077CK	080800360	PENTA® NOZZLE Ø 1.8 CP		
	074077CKV	080800360	PENTA® NOZZLE Ø 1.8 CP		

San Giorgio Plasma Parts srls is not affiliated with the named manufacturers. Reference to machines, parts, descriptions, and model numbers are for convenience in verifying compatibility only. All parts are made by or for San Giorgio Plasma Parts srls and are not made by the reference manufactures (unless expressly indicated). All other trademarks are the properties of their respective owners."

Replacement parts suitable for CUTLITE PENTA®

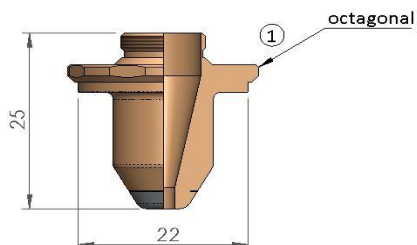

POS	LS. CODE	ORIGINAL CODE	DESCRIPTION	unit price	5 pack price
1	074078CK	080800384	PENTA® NOZZLE Ø 2.0 CP		
	074078CKV	080800384	PENTA® NOZZLE Ø 2.0 CP		
	074079CK	080800365	PENTA® NOZZLE Ø 3.0 CP		
	074079CKV	080800365	PENTA® NOZZLE Ø 3.0 CP		
	074081CK	080800366	PENTA® NOZZLE Ø 4.0 CP		
	074081CKV	080800366	PENTA® NOZZLE Ø 4.0 CP		
	074083CK	080800386	PENTA® NOZZLE Ø 5.0 CP		
	074083CKV	080800386	PENTA® NOZZLE Ø 5.0 CP		

San Giorgio Plasma Parts srls is not affiliated with the named manufacturers. Reference to machines, parts, descriptions, and model numbers are for convenience in verifying compatibility only. All parts are made by or for San Giorgio Plasma Parts srls and are not made by the reference manufactures (unless expressly indicated). All other trademarks are the properties of their respective owners."

Replacement parts suitable for CUTLITE PENTA®

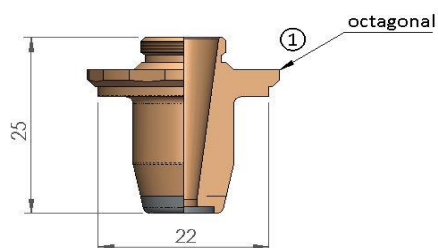

POS	LS. CODE	ORIGINAL CODE	DESCRIPTION	unit price	5 pack price
1	074096CK	080800367	PENTA® NOZZLE Ø 3.5 CP		
	074096CKV	080800367	PENTA® NOZZLE Ø 3.5 CP		
	074097CK	080800368	PENTA® NOZZLE Ø 5.0 CP		
	074097CKV	080800368	PENTA® NOZZLE Ø 5.0 CP		
	074098CK	080800383	PENTA® NOZZLE Ø 6.0 CP		
	074098CKV	080800383	PENTA® NOZZLE Ø 6.0 CP		

San Giorgio Plasma Parts srls is not affiliated with the named manufacturers. Reference to machines, parts, descriptions, and model numbers are for convenience in verifying compatibility only. All parts are made by or for San Giorgio Plasma Parts srls and are not made by the reference manufactures (unless expressly indicated). All other trademarks are the properties of their respective owners."

Replacement parts suitable for CUTLITE PENTA®

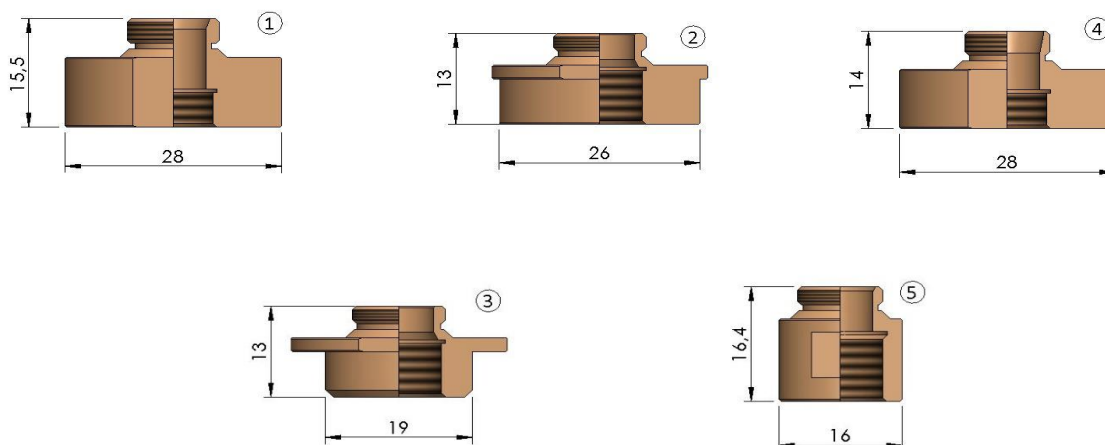

POS	LS. CODE	ORIGINAL CODE	DESCRIPTION	unit price	10 pack price
1	079010		PENTA® ADAPTER EXTENTION		
2	079011		PENTA® ADAPTER		
3	079012		PENTA® ADAPTER EXTENTION		
4	079013		PENTA® ADAPTER		
5	079014		PENTA® ADAPTER		

San Giorgio Plasma Parts srls is not affiliated with the named manufacturers. Reference to machines, parts, descriptions, and model numbers are for convenience in verifying compatibility only. All parts are made by or for San Giorgio Plasma Parts srls and are not made by the reference manufactures (unless expressly indicated). All other trademarks are the properties of their respective owners."

Replacement parts suitable for CUTLITE PENTA®



POS	LS. CODE	ORIGINAL CODE	DESCRIPTION	unit price	10 pack price
1	051006W	P0591-573-00015-281463-29100235-080800230	PRECITEC® NOZZLE Ø 1.5 HD		
	051008W	10.03.11.09.011-281550-P0591-575-00020-29100237-080800231	PRECITEC® NOZZLE Ø 2.0 HD		
	051010W	10.03.11.09.012-281551-P0591-576-00025-29100239-080800232	PRECITEC® NOZZLE Ø 2.5 HD		
	051012W	P0591-577-00030 10.03.11.09.013-29100241-080800233	PRECITEC® NOZZLE Ø 3.0 HD		
	051014W	10.03.11.09.014-29100243-080800234	PRECITEC® NOZZLE Ø 3.5 HD		
2	051006CW	281463-P0591-573-00015	PRECITEC® NOZZLE Ø 1.5 HD CP		
	051008CW	281550-P0591-575-00020	PRECITEC® NOZZLE Ø 2.0 HD CP		
	051010CW	281551-P0591-576-00025	PRECITEC® NOZZLE Ø 2.5 HD CP		
	051012CW		PRECITEC® NOZZLE Ø 3.0 HD CP		
	051014CW		PRECITEC® NOZZLE Ø 3.5 HD CP		

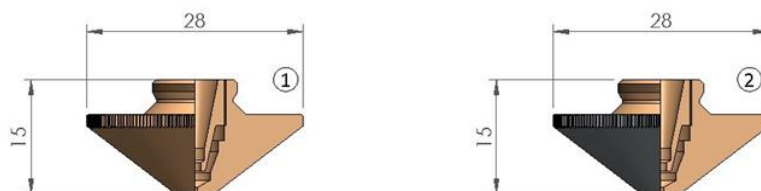

POS	LS. CODE	ORIGINAL CODE	DESCRIPTION	unit price	10 pack price
1	051037W	10.03.11.09.029-080800217	PRECITEC® DOUBLE NOZZLE Ø 5.0		
2	051037CW		PRECITEC® DOUBLE NOZZLE Ø 5.0 CP		

San Giorgio Plasma Parts srls is not affiliated with the named manufacturers. Reference to machines, parts, descriptions, and model numbers are for convenience in verifying compatibility only. All parts are made by or for San Giorgio Plasma Parts srls and are not made by the reference manufactures (unless expressly indicated). All other trademarks are the properties of their respective owners."

Replacement parts suitable for CUTLITE PENTA®

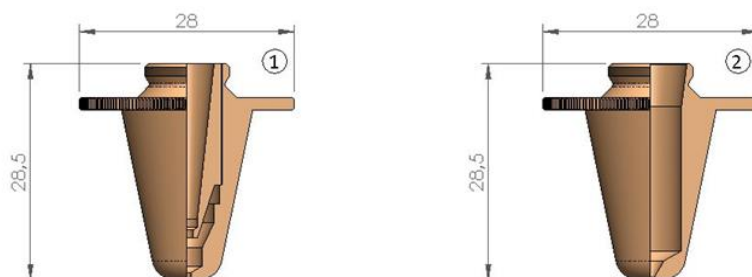

POS	LS. CODE	ORIGINAL CODE	DESCRIPTION	unit price	10 pack price
1	053027	080800198	PRECITEC® DOUBLE NOZZLE Ø 1.5		
	053027V		PRECITEC® DOUBLE NOZZLE Ø 1.5		
	053029	080800200	PRECITEC® DOUBLE NOZZLE Ø 2.0		
	053029V		PRECITEC® DOUBLE NOZZLE Ø 2.0		
	053031	080800202	PRECITEC® DOUBLE NOZZLE Ø 2.5		
	053031V		PRECITEC® DOUBLE NOZZLE Ø 2.5		
	053032	080800203	PRECITEC® DOUBLE NOZZLE Ø 3.0		
	053032V		PRECITEC® DOUBLE NOZZLE Ø 3.0		
2	053039	P0573-563-00015	PRECITEC® NOZZLE Ø 1.5		
	053039V	P0573-563-00015	PRECITEC® NOZZLE Ø 1.5		
	053041	P0573-564-00020	PRECITEC® NOZZLE Ø 2.0		
	053041V	P0573-564-00020	PRECITEC® NOZZLE Ø 2.0		
	053042	P0573-566-00025	PRECITEC® NOZZLE Ø 2.5		
	053042V	P0573-566-00025	PRECITEC® NOZZLE Ø 2.5		
	053043		PRECITEC® NOZZLE Ø 3.0		
	053043V		PRECITEC® NOZZLE Ø 3.0		

San Giorgio Plasma Parts srls is not affiliated with the named manufacturers. Reference to machines, parts, descriptions, and model numbers are for convenience in verifying compatibility only. All parts are made by or for San Giorgio Plasma Parts srls and are not made by the reference manufactures (unless expressly indicated). All other trademarks are the properties of their respective owners."