

TRAFIMET®
A53 - S54

while stocks last

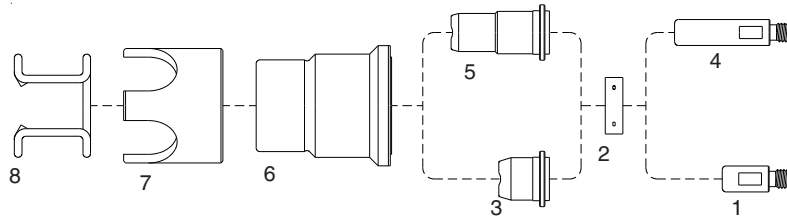

No.	Ref.	Code	Description	No.	Ref.	Code	Description
1	PR105	52536	Electrode		PD103	51317	Extended tip \varnothing 1.0
2	PE106	60028	Swirl ring	6	PC115	60384	Retaining cap for S54
3	PD102-10	51315	Tip \varnothing 1.0	7	CV33	60378	Crown spacer
4	PR106	52532	Extended electrode	8	CV28	51902	Spacer spring
5	PD103-09	51317.09	Extended tip \varnothing 0.9				

TRAFIMET®
A60

while stocks last

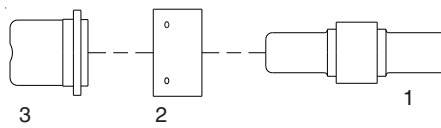

No.	Ref.	Code	Description	No.	Ref.	Code	Description
1	PR107	52537	Electrode	3	PD105.10	51170	Tip \varnothing 1.0
2	PE107	60029	Swirl ring		PD105.11	51172	Tip \varnothing 1.1

Series PT
Suitable for TRAFIMET®
S25 - S25 K
S30 - S35 K
S45

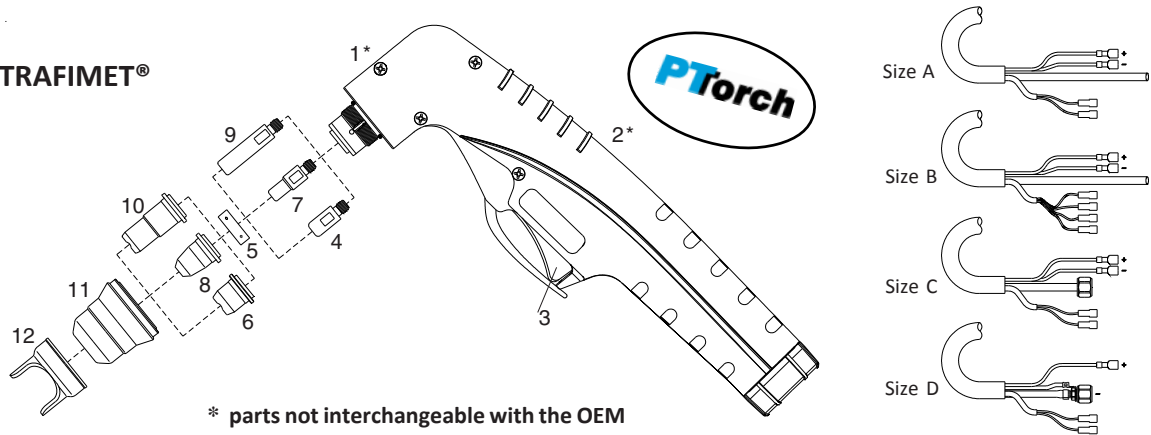

No.	Ref.	Code	Description	No.	Ref.	Code	Description
	PA0370	09622	Hand torch PT-20C, 4m, size B		PD0116-08	51316	Tip \varnothing 0.8
	PA0375	09623	Hand torch PT-20C, 4m, size A		PD0116-09	51316.09	Tip \varnothing 0.9
	PA0376	09620	Hand torch PT-20C, 4m, size A	9	PR0106	52532	Extended electrode
	PA0167	09632	Hand torch PT-40, 4m, 1/4G, size C	10	PD0103-09	51317.09	Extended tip \varnothing 0.9
	PA0165	09634	Hand torch PT-40, 6m, 1/4G, size D		PD0103-10	51317	Extended tip \varnothing 1.0
	PA0166	09635	Hand torch PT-40, 6m, central conn.	11	PC116	60389	Retaining cap
1*		09600	Torch head PT-20C		PC122	60389K1	Retaining cap (1 hole)
		09602	Torch head PT-40		PC117	60389K	Retaining cap (2 holes)
2*		09605	Handle with Switch		PC135	60389K4	Retaining cap (4 holes)
3	BX0020	07301.20	Switch	12		60431	Double Pointed Spacer
4	PR0105	52536	Electrode	*		09682	Cable 4m, PT-20C, size B
5	PE0106	60028	Swirl ring	*		09680	Cable 4m, PT-20C, size A
6	PD0102-09	51315.09	Tip \varnothing 0.9	*		09687	Cable 4m, PT-40, 1/4G, size C
	PD0102-10	51315	Tip \varnothing 1.0	*		09688	Cable 6m, PT-40, 1/4G, size D
7	PR0110	52531	Electrode	*		09689	Cable 6m, PT-40, cent. conn.
8	PD0116-06	51316.06	Tip \varnothing 0.65				

Replacement parts suitable for:

TRAFIMET®

A80-P80®

A81-P81®

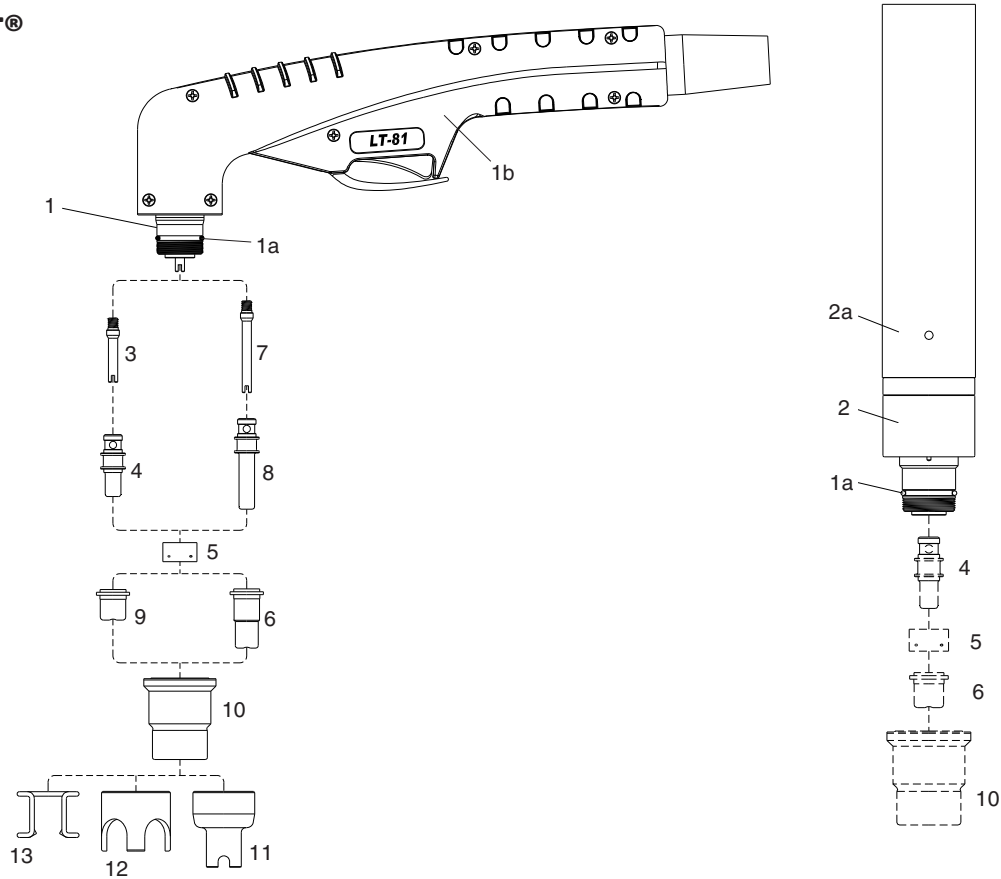

No.	Ref.	Code	Description	No.	Ref.	Code	Description
	PA170	06820LT	Hand torch 6m 3/8 G - 1/4 G	6	PD105-11	51172	Tip ø 1.1
	PA1402	06821LT	Hand torch 6m cent. connector		PD105-12	51172.12	Tip ø 1.2
	PA180	06840	Machine torch 6m 3/8 G	7	FH0561	06801.43	Extended diffusor
	PA181	06841	Machine torch 6m cent. connector	8	PR115	52581/S	Extended electrode
1	PF119	06802	Hand torch head	9	PD106-10	51171.10	Extended tip ø 1.0
1a	EA125	07300.60	O-Ring		PD106-12	51173	Extended tip ø 1.2
1b		09706	Handgrip with microswitch	10	PC115	60384	Retaining cap
2	PF120	06811	Machine torch head	11	CV201	51976	Spacer for contact cutting
2a	TP61	06815	Machine handle	12	CV33	60378	Crown spacer
3	FH0560	06801.42	Diffusor	13	CV28	51902	Spacer spring
4	PR109	52580/S	Electrode		PH130/132	06880	Cable 6m 3/8G - 1/4G
5	PE107	60029	Swirl ring				Hand/Machine torch
6	PD105-10	51170	Tip ø 1.0		PF0140	06802/KIT	Torch Head with handle



Notes

TRAFIMET®
A90-P90®

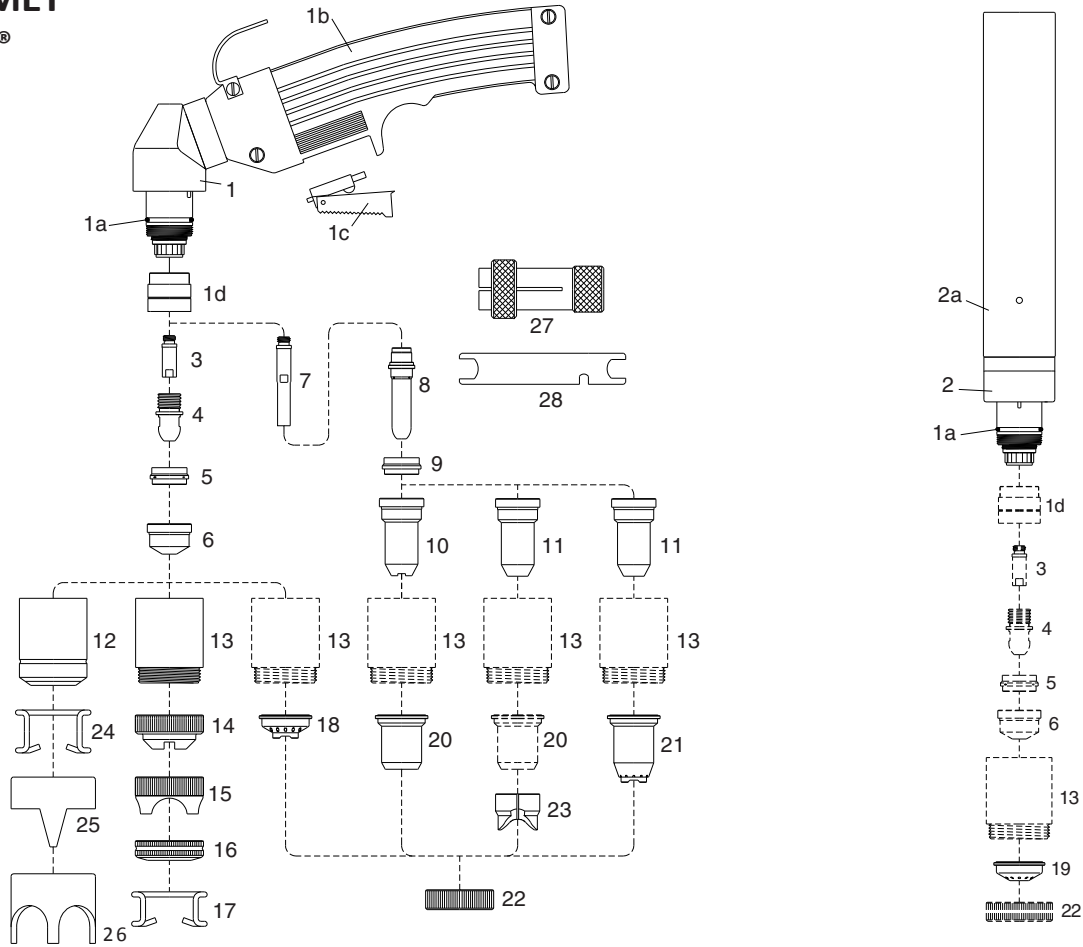

No.	Ref.	Code	Description	No.	Ref.	Code	Description
	PA109	06050	Hand torch 6m M14x1	11	PD117-14	51149.14	Extended tip \varnothing 1.4
		06051	Hand torch 6m central connector		PD117-17	51149.17	Extended tip \varnothing 1.7
	PA209	06150	Hand torch 12m M14x1	12	PC109/111	60376	Retaining cap, long life
		06151	Hand torch 12m (central connector)	13	PC113/130	60386	Contact retaining cap
	PA110	06650	Machine torch 6m M14x1		PC113/130	60386/v	Contact retaining cap, Max.life
	PA111	06651	Machine torch 6m central connector	14	CV23	51940	Spacer for contact cutting
		06750	Machine torch 12m M14x1	15	CV39	51945	Large spacer for contact cutting
		06751	Machine torch 12m central connector	16		51952	Spring holder protection nut
1	PF109	06000	Hand torch head	17		51911	Spacer spring for code 51952
1a	EA131	06000.60	O-Ring	18		51950	Spacer for contact cutting, hand
1b		07301	Handgrip complete with switch	19		51951	Shield cup, machine
1c		07301.20	Switch	20	CV8	51957	Shield cup, hand max. 50A
1d		60085	Front insulator	21	CV9	51958	Spacer for contact cutting, hand
2	PF115	06600	Machine torch head	22		51959	Locking nut
2a		03310	Machine handle	23		51974	Spacer for extended tips High Amp.
3		06004	Diffusor	24	CV11	51910	Spacer spring
4	PR101	52535	Electrode	25	CV12	60370	Double pointed spacer
5	PE101	60030	Swirl ring	26	CV14	60371	Crown spacer
6	PD101-11	51154	Tip \varnothing 1.1	27	GR60	60369	Extractor for swirl ring
	PD101-14	51155	Tip \varnothing 1.4	28		60368	Wrench for electrode
	PD101-17	51156	Tip \varnothing 1.7				
7		06005	Extended Diffusor			04224	Cable 6m M14x1 - Hand torch
8	PR116	52530	Extended electrode			04234	Cable 12m M14x1 - Hand torch
9	PE103	60031	Insulating spacer			04222	Cable 6m M14x1 - Machine torch
10	PD111	51149	Extended tip \varnothing 1.1 (max. 50A)			04232	Cable 12m M14x1 - Machine torch

Replacement parts suitable for:

TRAFIMET®
A140-P140®

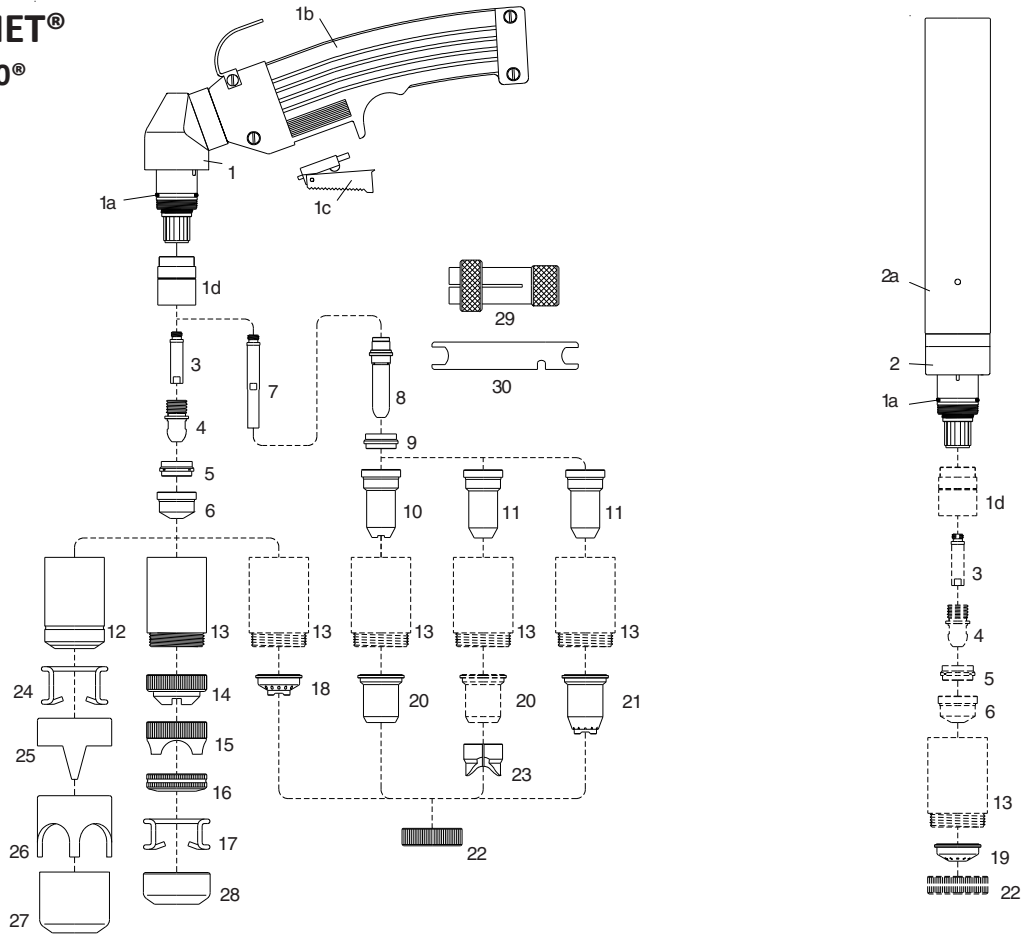

No.	Ref.	Code	Description	No.	Ref.	Code	Description
PA101	06250		Hand torch 6m M14 x 1	11	PD117-14	51149.14	Extended tip ø 1.4
	06251		Hand torch 6m cent. connector		PD117-17	51149.17	Extended tip ø 1.7
PA102	06350		Hand torch 12m M14 x 1		PD117-19	51149.19	Extended tip ø 1.9
	06351		Hand torch 12m cent. connector	12	PC101/102	60375	Retaining cap, long life
PA103	06450		Machine torch 6m M14 x 1	13	PC103/131	60385	Contact retaining cap
PA145	06451		Machine torch 6m cent. connector		PC103/131	60385/V	Contact retaining cap, Max.life
PA104	06550		Machine torch 12m M14 x 1	14	CV23	51940	Spacer for contact cutting
PA146	06551		Machine torch 12m cent.conn.	15	CV39	51945	Large spacer for contact cutting
1	PF101	06200	Hand torch head	16		51952	Spring holder protection nut
1a	EA131	06000.60	O - Ring	17		51911	Spacer spring for code 51952
1b		07301	Handgrip complete with switch	18		51950	Spacer for contact cutting, hand
1c		07301.20	Switch	19		51951	Shield cup, machine
1d		60080	Front insulator	20	CV8	51957	Shield cup, hand (max. 50A)
2	PF102	06400	Machine torch head	21	CV9	51958	Spacer for contact cutting, hand
2a		03310	Machine handle	22		51959	Locking nut
3		05004	Diffusor	23		51974	Spacer for extended tips High Amp.
4	PR101	52535	Electrode	24	CV11	51910	Spacer spring
5	PE101	60030	Swirl ring	25	CV12	60370	Double pointed spacer
6	PD101-11	51154	Tip ø 1.1	26	CV14	60371	Crown spacer
	PD101-14	51155	Tip ø 1.4	27	CV13	60373	Gouging spacer
	PD101-17	51156	Tip ø 1.7	28		51953	Gouging spacer
	PD101-19	51157	Tip ø 1.9	29	GR60	60369	Extractor for swirl ring
	PD101-30	51158	Gouging tip ø 3.0	30		60368	Wrench for electrode
7		05005	Extended Diffusor			04220	Cable 6m M14 x 1 - Hand torch
8	PR116	52530	Extended electrode			04230	Cable 12m M14 x 1 - Hand torch
9	PE103	60031	Insulating spacer			04222	Cable 6m M14 x 1 - Machine torch
10	PD111	51149	Extended tip ø 1.1 (max. 50A)			04232	Cable 12m M14 x 1 - Machine torch

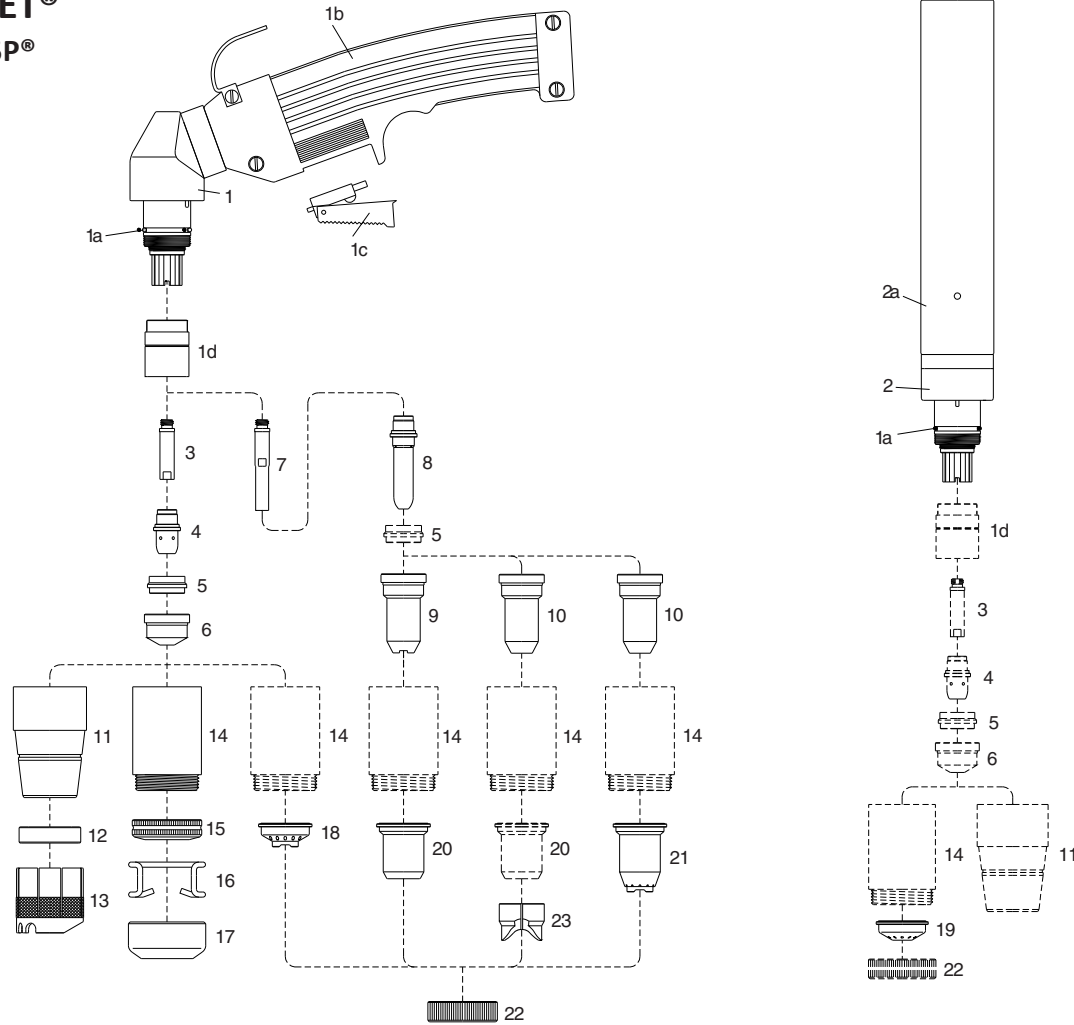
TRAFIMET®
R145-R145P®

No.	Ref.	Code	Description	No.	Ref.	Code	Description
	PA129	06920/S	Hand torch 6m M14 x 1	8	PR116	52530	Extended electrode
		06921/S	Hand torch 6m cent. connector	9	PD111	51149	Extended tip \varnothing 1.1 (max 50A)
	PA130	06930/S	Hand torch 12m M14 x 1	10	PD117-14	51149.14	Extended tip \varnothing 1.4
		06931/S	Hand torch 12m cent. conn.		PD117-17	51149.17	Extended tip \varnothing 1.7
	PA127	06940/S	Machine torch 6m M14 x 1		PD117-19	51149.19	Extended tip \varnothing 1.9
	PA252	06941/S	Machine torch 6m cent. conn.	11	PC120	60387	Retaining cap
	PA128	06950/S	Machine torch 12m M14 x 1	12	BW139	60388	Nozzle shield
	PA253	06951/S	Machine torch 12m cent. conn.	13	CV1105	60379	Cage spacer
1	PF112	06900	Hand torch head	14	PC103/131	60385	Contact retaining cap
1a	EA131	06000.60	O - Ring		PC103/131	60385/V	Contact retaining cap, Max.life
1b		07301	Handgrip complete with switch	15		51952	Spring holder protection nut
1c		07301.20	Switch	16		51911	Spacer spring for code 51952
1d		60080	Front insulator	17		51953	Gouging spacer
2	PF111	06910	Machine torch head	18		51950	Spacer for contact cutting, hand
2a		03310	Machine handle	19		51951	Shield cup, machine
3		05004	Diffusor	20	CV8	51957	Shield cup, hand (max. 50A)
4	PR111	52534	Electrode	21	CV9	51958	Spacer for contact cutting, hand
5	PE103	60031	Insulating spacer	22		51959	Locking nut
6	PD109-14	51241	Tip \varnothing 1.4	23		51974	Spacer for extended tips High Amp.
	PD109-16	51242	Tip \varnothing 1.6			04220/S	Cable 6m (M14x1) - Hand torch
	PD109-18	51243	Tip \varnothing 1.8			04230/S	Cable 12m (M14x1) - Hand torch
	PD109-30	51244	Gouging tip \varnothing 3.0			04222/S	Cable 6m (M14x1) - Machine torch
7		05005	Extended Diffusor			04232/S	Cable 12m (M14x1) - Machine torch