

## Replacement parts suitable for BYSTRONIC®

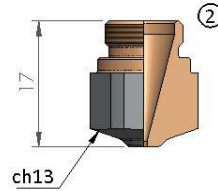

POS	LS. CODE	ORIGINAL CODE	DESCRIPTION	unit price	10 pack price
1	151001W	3-04277 HK08	BYSTRONIC® NOZZLE Ø 0.8 HD		
	151002W	3-01910 HK10	BYSTRONIC® NOZZLE Ø 1.0 HD		
	151003W	3-01911 HK12	BYSTRONIC® NOZZLE Ø 1.25 HD		
	151004W	3-01912 HK15	BYSTRONIC® NOZZLE Ø 1.5 HD		
	151005W	3-01913 HK17	BYSTRONIC® NOZZLE Ø 1.75 HD		
2	151001CW	3-04277 HK08	BYSTRONIC® NOZZLE Ø 0.8 HD CP		
	151002CW	3-01910 HK10	BYSTRONIC® NOZZLE Ø 1.0 HD CP		
	151003CW	3-01911 HK12	BYSTRONIC® NOZZLE Ø 1.25 HD CP		
	151004CW	3-01912 HK15	BYSTRONIC® NOZZLE Ø 1.5 HD CP		
	151005CW	3-01913 HK17	BYSTRONIC® NOZZLE Ø 1.75 HD CP		

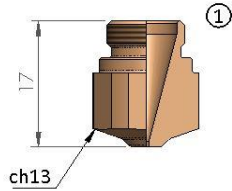
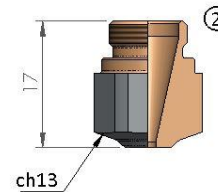
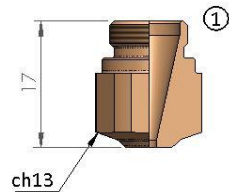

POS	LS. CODE	ORIGINAL CODE	DESCRIPTION	unit price	10 pack price
1	151006W	3-01914 HK20	BYSTRONIC® NOZZLE Ø 2.0 HD		
	151007W	3-03854 HK25	BYSTRONIC® NOZZLE Ø 2.5 HD		
	151008W	3-06112 HK30	BYSTRONIC® NOZZLE Ø 3.0 HD		
	151009W	HK35	BYSTRONIC® NOZZLE Ø 3.5 HD		
	151010W	HK40	BYSTRONIC® NOZZLE Ø 4.0 HD		
2	151006CW	3-01914 HK20	BYSTRONIC® NOZZLE Ø 2.0 HD CP		
	151007CW	3-03854 HK25	BYSTRONIC® NOZZLE Ø 2.5 HD CP		
	151008CW	3-06112 HK30	BYSTRONIC® NOZZLE Ø 3.0 HD CP		
	151009CW	HK35	BYSTRONIC® NOZZLE Ø 3.5 HD CP		
	151010CW	HK40	BYSTRONIC® NOZZLE Ø 4.0 HD CP		

San Giorgio Plasma Parts srls is not affiliated with the named manufacturers. Reference to machines, parts, descriptions, and model numbers are for convenience in verifying compatibility only. All parts are made by or for San Giorgio Plasma Parts srls and are not made by the reference manufactures (unless expressly indicated). All other trademarks are the properties of their respective owners."

## Replacement parts suitable for BYSTRONIC®

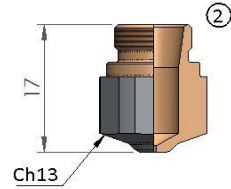
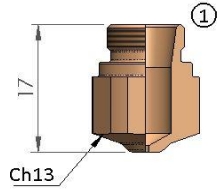

POS	LS. CODE	ORIGINAL CODE	DESCRIPTION	unit price	10 pack price
1	151014W	3-04273 K08	BYSTRONIC® NOZZLE Ø 0.8		
	151015W	3-01905 K10	BYSTRONIC® NOZZLE Ø 1.0		
	151016W	3-01906 K12	BYSTRONIC® NOZZLE Ø 1.25		
	151017W	3-01907 K15	BYSTRONIC® NOZZLE Ø 1.5		
	151018W	3-01908 K17	BYSTRONIC® NOZZLE Ø 1.75		
	151019W	3-01909 K20	BYSTRONIC® NOZZLE Ø 2.0		
	151020W	3-04274 K25	BYSTRONIC® NOZZLE Ø 2.5		
	151021W	3-04275 K30	BYSTRONIC® NOZZLE Ø 3.0		
2	151014CW	3-04273 K08	BYSTRONIC® NOZZLE Ø 0.8 CP		
	151015CW	3-01905 K10	BYSTRONIC® NOZZLE Ø 1.0 CP		
	151016CW	3-01906 K12	BYSTRONIC® NOZZLE Ø 1.25 CP		
	151017CW	3-01907 K15	BYSTRONIC® NOZZLE Ø 1.5 CP		
	151018CW	3-01908 K17	BYSTRONIC® NOZZLE Ø 1.75 CP		
	151019CW	3-01909 K20	BYSTRONIC® NOZZLE Ø 2.0 CP		
	151020CW	3-04274 K25	BYSTRONIC® NOZZLE Ø 2.5 CP		
	151021CW	3-04275 K30	BYSTRONIC® NOZZLE Ø 3.0 CP		

## Replacement parts suitable for BYSTRONIC®

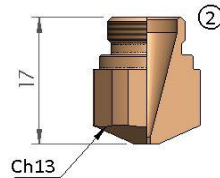
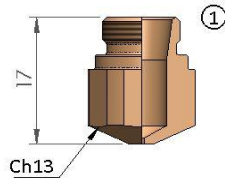

POS	LS. CODE	ORIGINAL CODE	DESCRIPTION	unit price	10 pack price
1	151023W	3-04273 K08	BYSTRONIC® NOZZLE Ø 0.8		
	151024W	3-01905 K10	BYSTRONIC® NOZZLE Ø 1.0		
	151025W	3-01906 K12	BYSTRONIC® NOZZLE Ø 1.25		
	151026W	3-01907 K15	BYSTRONIC® NOZZLE Ø 1.5		
	151027W	3-01908 K17	BYSTRONIC® NOZZLE Ø 1.75		
	151028W	3-01909 K20	BYSTRONIC® NOZZLE Ø 2.0		
2	151035W	3-01910 HK10	BYSTRONIC® NOZZLE Ø 1.0		
	151036W	3-01911 HK12	BYSTRONIC® NOZZLE Ø 1.25		
	151037W	3-01912 HK15	BYSTRONIC® NOZZLE Ø 1.5		
	151038W	3-01913 HK17	BYSTRONIC® NOZZLE Ø 1.75		
	151039W	3-01914 HK20	BYSTRONIC® NOZZLE Ø 2.0		

## Replacement parts suitable for BYSTRONIC®

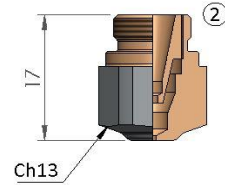
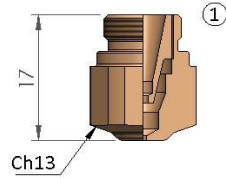

POS	LS. CODE	ORIGINAL CODE	DESCRIPTION	unit price	10 pack price
1	151040W	3-16058 NK10 - 15	BYSTRONIC® DOUBLE NOZZLE Ø 1.0		
	151041W	3-16059 NK12- 15	BYSTRONIC® DOUBLE NOZZLE Ø 1.25		
	151042W	3-16060 NK15- 15	BYSTRONIC® DOUBLE NOZZLE Ø 1.5		
	151043W	3-14317 NK17 - 15	BYSTRONIC® DOUBLE NOZZLE Ø 1.75		
	151044W	3-14318 NK20 - 15	BYSTRONIC® DOUBLE NOZZLE Ø 2.0		
	151045W	3-14319 NK25 - 15	BYSTRONIC® DOUBLE NOZZLE Ø 2.5		
	151046W	3-16256 NK25 - 20	BYSTRONIC® DOUBLE NOZZLE Ø 2.5		
	151047W	3-16061 NK30 - 17	BYSTRONIC® DOUBLE NOZZLE Ø 3.0		
	151048W	3-16257 NK30 - 20	BYSTRONIC® DOUBLE NOZZLE Ø 3.0		
	151049W	NK35-30	BYSTRONIC® DOUBLE NOZZLE Ø 3.5		
2	151040CW	3-16058 NK10 - 15	BYSTRONIC® DOUBLE NOZZLE Ø 1.0 CP		
	151041CW	3-16059 NK12- 15	BYSTRONIC® DOUBLE NOZZLE Ø 1.25 CP		
	151042CW	3-16060 NK15- 15	BYSTRONIC® DOUBLE NOZZLE Ø 1.5CP		
	151043CW	3-14317 NK17 - 15	BYSTRONIC® DOUBLE NOZZLE Ø 1.75 CP		
	151044CW	3-14318 NK20 - 15	BYSTRONIC® DOUBLE NOZZLE Ø 2.0 CP		
	151045CW	3-14319 NK25 - 15	BYSTRONIC® DOUBLE NOZZLE Ø 2.5 CP		
	151046CW	3-16256 NK25 - 20	BYSTRONIC® DOUBLE NOZZLE Ø 2.5 CP		
	151047CW	3-16061 NK30 - 17	BYSTRONIC® DOUBLE NOZZLE Ø 3.0 CP		
	151048CW	3-16257 NK30 - 20	BYSTRONIC® DOUBLE NOZZLE Ø 3.0 CP		
	151049CW	NK35-30	BYSTRONIC® DOUBLE NOZZLE Ø 3.5 CP		

San Giorgio Plasma Parts srls is not affiliated with the named manufacturers. Reference to machines, parts, descriptions, and model numbers are for convenience in verifying compatibility only. All parts are made by or for San Giorgio Plasma Parts srls and are not made by the reference manufactures (unless expressly indicated). All other trademarks are the properties of their respective owners."

## Replacement parts suitable for BYSTRONIC®

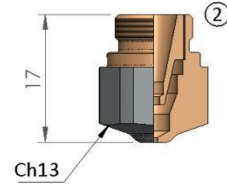
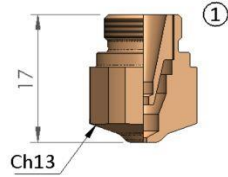

POS	LS. CODE	ORIGINAL CODE	DESCRIPTION	unit price	10 pack price
1	151030W	3-16058 NK10 - 15	BYSTRONIC® DOUBLE NOZZLE Ø 1.0		
	151031W	3-16059 NK12 - 15	BYSTRONIC® DOUBLE NOZZLE Ø 1.25		
	151032W	3-16060 NK15 - 15	BYSTRONIC® DOUBLE NOZZLE Ø 1.5		
	151033W	3-14317 NK17 - 15	BYSTRONIC® DOUBLE NOZZLE Ø 1.75		
2	151030CW	3-16058 NK10 - 15	BYSTRONIC® DOUBLE NOZZLE Ø 1.0 CP		
	151031CW	3-16059 NK12 - 15	BYSTRONIC® DOUBLE NOZZLE Ø 1.25 CP		
	151032CW	3-16060 NK15 - 15	BYSTRONIC® DOUBLE NOZZLE Ø 1.5 CP		
	151033CW	3-14317 NK17 - 15	BYSTRONIC® DOUBLE NOZZLE Ø 1.75 CP		

## Replacement parts suitable for BYSTRONIC®

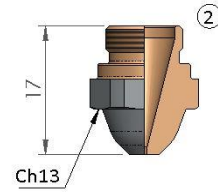
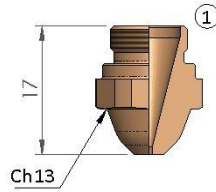

POS	LS. CODE	ORIGINAL CODE	DESCRIPTION	unit price	10 pack price
1	151055W	3-04275 H08	BYSTRONIC® NOZZLE Ø 0.8 HD		
	151056W	3-01899 H10	BYSTRONIC® NOZZLE Ø 1.0 HD		
	151057W	3-01900 H12	BYSTRONIC® NOZZLE Ø 1.25 HD		
	151058W	3-01901 H15	BYSTRONIC® NOZZLE Ø 1.5 HD		
	151059W	3-01902 H17	BYSTRONIC® NOZZLE Ø 1.75 HD		
	151060W	3-01903 H20	BYSTRONIC® NOZZLE Ø 2.0 HD		
	151061W	3-04276 H25	BYSTRONIC® NOZZLE Ø 2.5 HD		
	151062W	H30	BYSTRONIC® NOZZLE Ø 3.0 HD		
2	151055CW	3-04275 H08	BYSTRONIC® NOZZLE Ø 0.8 HD CP		
	151056CW	3-01899 H10	BYSTRONIC® NOZZLE Ø 1.0 HD CP		
	151057CW	3-01900 H12	BYSTRONIC® NOZZLE Ø 1.25 HD CP		
	151058CW	3-01901 H15	BYSTRONIC® NOZZLE Ø 1.5 HD CP		
	151059CW	3-01902 H17	BYSTRONIC® NOZZLE Ø 1.75 HD CP		
	151060CW	3-01903 H20	BYSTRONIC® NOZZLE Ø 2.0 HD CP		
	151061CW	3-04276 H25	BYSTRONIC® NOZZLE Ø 2.5 HD CP		
	151062CW	H30	BYSTRONIC® NOZZLE Ø 3.0 HD CP		

## Replacement parts suitable for BYSTRONIC®

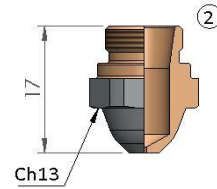
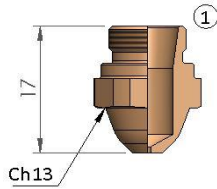

POS	LS. CODE	ORIGINAL CODE	DESCRIPTION	unit price	10 pack price
1	151065W	3-04271 08	BYSTRONIC® NOZZLE Ø 0.8		
	151066W	3-01894 10	BYSTRONIC® NOZZLE Ø 1.0		
	151067W	3-01895 12	BYSTRONIC® NOZZLE Ø 1.25		
	151068W	3-01896 15	BYSTRONIC® NOZZLE Ø 1.5		
	151069W	3-01897 17	BYSTRONIC® NOZZLE Ø 1.75		
	151070W	3-01898 20	BYSTRONIC® NOZZLE Ø 2.0		
	151071W	3-04272 25	BYSTRONIC® NOZZLE Ø 2.5		
2	151065CW	3-04271 08	BYSTRONIC® NOZZLE Ø 0.8 CP		
	151066CW	3-01894 10	BYSTRONIC® NOZZLE Ø 1.0 CP		
	151067CW	3-01895 12	BYSTRONIC® NOZZLE Ø 1.25 CP		
	151068CW	3-01896 15	BYSTRONIC® NOZZLE Ø 1.5 CP		
	151069CW	3-01897 17	BYSTRONIC® NOZZLE Ø 1.75 CP		
	151070CW	3-01898 20	BYSTRONIC® NOZZLE Ø 2.0 CP		
	151071CW	3-04272 25	BYSTRONIC® NOZZLE Ø 2.5 CP		

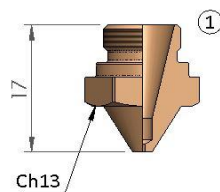

POS	LS. CODE	ORIGINAL CODE	DESCRIPTION	unit price	10 pack price
1	151085W	3-04271 08	BYSTRONIC® NOZZLE Ø 0.8		
	151086W	3-01894 10	BYSTRONIC® NOZZLE Ø 1.0		
	151087W	3-01895 12	BYSTRONIC® NOZZLE Ø 1.25		
	151088W	3-01896 15	BYSTRONIC® NOZZLE Ø 1.5		
	151089W	3-01897 17	BYSTRONIC® NOZZLE Ø 1.75		
	151090W	3-01898 20	BYSTRONIC® NOZZLE Ø 2.0		

San Giorgio Plasma Parts srls is not affiliated with the named manufacturers. Reference to machines, parts, descriptions, and model numbers are for convenience in verifying compatibility only. All parts are made by or for San Giorgio Plasma Parts srls and are not made by the reference manufactures (unless expressly indicated). All other trademarks are the properties of their respective owners."

## Replacement parts suitable for BYSTRONIC®

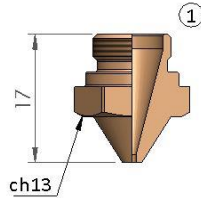

POS	LS. CODE	ORIGINAL CODE	DESCRIPTION	unit price	10 pack price
1	151092W	3-01899 H10	BYSTRONIC® DOUBLE NOZZLE Ø 1.0 HD		
	151093W	3-01900 H12	BYSTRONIC® DOUBLE NOZZLE Ø 1.25 HD		
	151094W	3-01901 H15	BYSTRONIC® DOUBLE NOZZLE Ø 1.5 HD		
	151095W	3-01902 H17	BYSTRONIC® DOUBLE NOZZLE Ø 1.75 HD		
	151096W	3-01903 H20	BYSTRONIC® DOUBLE NOZZLE Ø 2.0 HD		

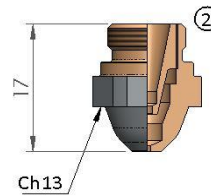
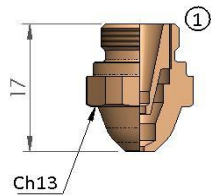

POS	LS. CODE	ORIGINAL CODE	DESCRIPTION	unit price	10 pack price
1	151075W	N10-15	BYSTRONIC® DOUBLE NOZZLE Ø 1.0		
	151076W	N12-15	BYSTRONIC® DOUBLE NOZZLE Ø 1.25		
	151077W	N15-15	BYSTRONIC® DOUBLE NOZZLE Ø 1.5		
	151078W	N17-15	BYSTRONIC® DOUBLE NOZZLE Ø 1.75		
	151079W	N20-15	BYSTRONIC® DOUBLE NOZZLE Ø 2.0		
	151080W	N25-15	BYSTRONIC® DOUBLE NOZZLE Ø 2.5		
	151081W	N25-20	BYSTRONIC® DOUBLE NOZZLE Ø 2.5		
	151082W	N30-17	BYSTRONIC® DOUBLE NOZZLE Ø 3.0		
	151083W	N30-20	BYSTRONIC® DOUBLE NOZZLE Ø 3.0		
2	151075CW	N10-15	BYSTRONIC® DOUBLE NOZZLE Ø 1.0 CP		
	151076CW	N12-15	BYSTRONIC® DOUBLE NOZZLE Ø 1.25 CP		
	151077CW	N15-15	BYSTRONIC® DOUBLE NOZZLE Ø 1.5 CP		
	151078CW	N17-15	BYSTRONIC® DOUBLE NOZZLE Ø 1.75 CP		
	151079CW	N20-15	BYSTRONIC® DOUBLE NOZZLE Ø 2.0 CP		
	151080CW	N25-15	BYSTRONIC® DOUBLE NOZZLE Ø 2.5 CP		
	151081CW	N25-20	BYSTRONIC® DOUBLE NOZZLE Ø 2.5 CP		
	151082CW	N30-17	BYSTRONIC® DOUBLE NOZZLE Ø 3.0 CP		
	151083CW	N30-20	BYSTRONIC® DOUBLE NOZZLE Ø 3.0 CP		

San Giorgio Plasma Parts srls is not affiliated with the named manufacturers. Reference to machines, parts, descriptions, and model numbers are for convenience in verifying compatibility only. All parts are made by or for San Giorgio Plasma Parts srls and are not made by the reference manufactures (unless expressly indicated). All other trademarks are the properties of their respective owners."



## Replacement parts suitable for BYSTRONIC®

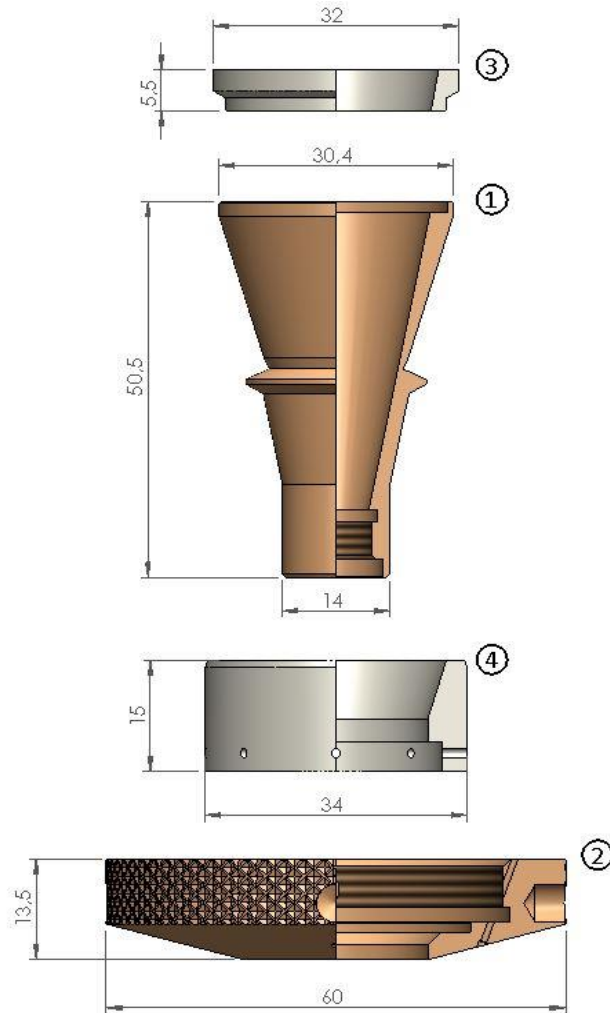

POS	LS. CODE	ORIGINAL CODE	DESCRIPTION	unit price	10 pack price
1	159020	2-10837	BYSTRONIC® NOZZLE BODY		
2	159025	3-13110	BYSTRONIC® COPPER SHIELD		
3	159022	3-13113	BYSTRONIC® INSULATING RING		
4	159024	3-13422	BYSTRONIC® INSULATING RING WITH HOLES		

San Giorgio Plasma Parts srls is not affiliated with the named manufacturers. Reference to machines, parts, descriptions, and model numbers are for convenience in verifying compatibility only. All parts are made by or for San Giorgio Plasma Parts srls and are not made by the reference manufactures (unless expressly indicated). All other trademarks are the properties of their respective owners."

## Replacement parts suitable for BYSTRONIC®

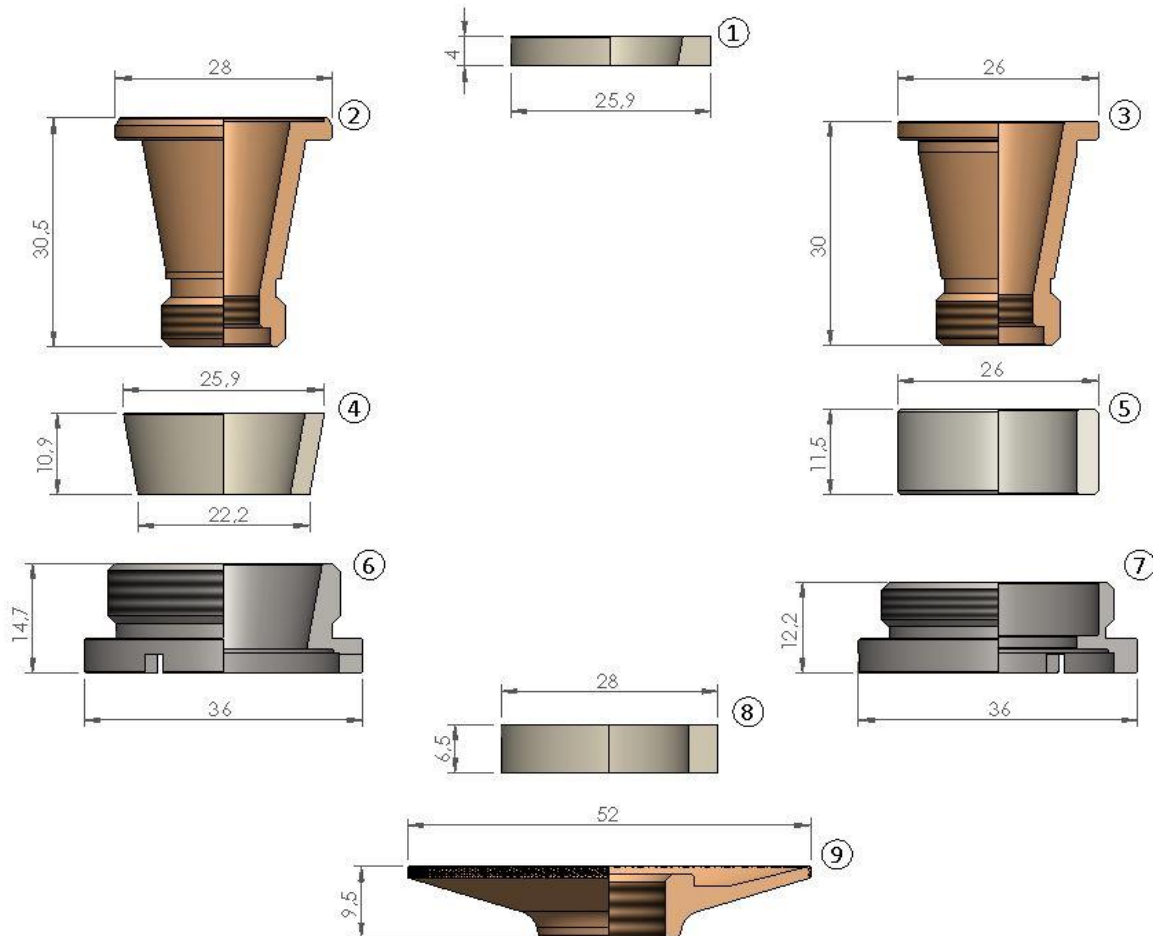

POS	LS. CODE	ORIGINAL CODE	DESCRIPTION	unit price	10 pack price
1	159004	4-01642	BYSTRONIC® CERAMIC INSULATING DISC		
	159005	4-01642	BYSTRONIC® CERAMIC INSULATING DISC NEW VERSION		
2	159001	2-08701	BYSTRONIC® NOZZLE BODY		
3	159002	10032930	BYSTRONIC® NOZZLE BODY		
4	159006	4-01959	BYSTRONIC® CERAMIC CONE		
	159007	4-01959	BYSTRONIC® CERAMIC CONE - NEW VERSION		
5	159010	10032838	BYSTRONIC® CERAMIC INSULATING RING		
6	159013	3-11071	BYSTRONIC® FASTENING NUT		
7	159014	10032839	BYSTRONIC® FASTENING NUT		
8	159008	4-09010	BYSTRONIC® CERAMIC INSULATING RING		
5	159017	2-08700	BYSTRONIC® SIGNBOARD		

San Giorgio Plasma Parts srls is not affiliated with the named manufacturers. Reference to machines, parts, descriptions, and model numbers are for convenience in verifying compatibility only. All parts are made by or for San Giorgio Plasma Parts srls and are not made by the reference manufactures (unless expressly indicated). All other trademarks are the properties of their respective owners."

## Replacement parts suitable for BYSTRONIC®

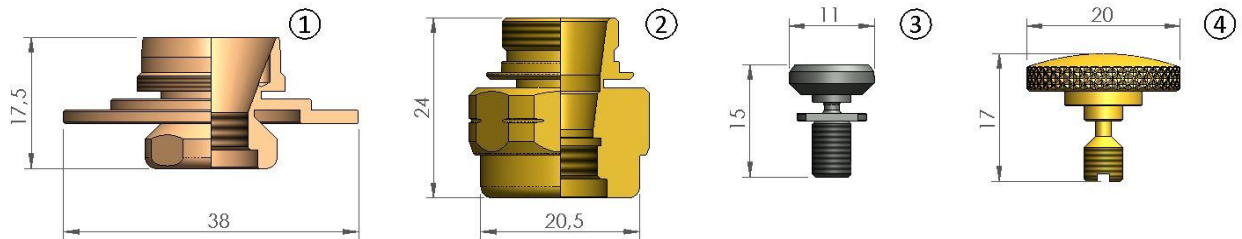

POS	LS. CODE	ORIGINAL CODE	DESCRIPTION	unit price	10 pack price
1	159035	10051133	BYSTRONIC® ADAPTER mSB		
2	159036	10064099	BYSTRONIC® NOZZLE BODY		
3	159029	3-09001	BYSTRONIC® SCREW FOR CROSS-JET		
4	159028	4-03136	BYSTRONIC® KNURLED SCREW - BRASS		

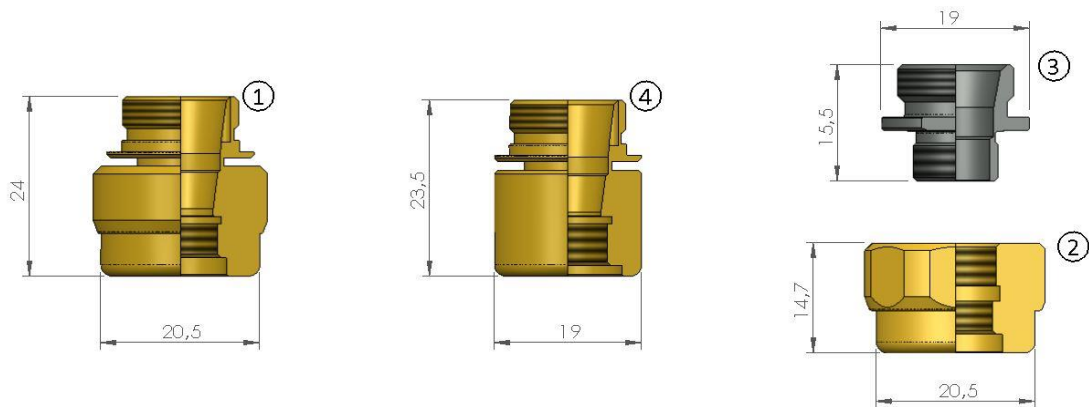

POS	LS. CODE	ORIGINAL CODE	DESCRIPTION	unit price	10 pack price
1	159037		BYSTRONIC® NOZZLE BODY		
2	159040	10071494	BYSTRONIC® NOZZLE BODY		
3	159041	10075057	BYSTRONIC® COUPLING		
4	159038		BISTRONIC® NOZZLE BODY		

San Giorgio Plasma Parts srls is not affiliated with the named manufacturers. Reference to machines, parts, descriptions, and model numbers are for convenience in verifying compatibility only. All parts are made by or for San Giorgio Plasma Parts srls and are not made by the reference manufactures (unless expressly indicated). All other trademarks are the properties of their respective owners."

## Replacement parts suitable for BYSTRONIC®



POS	LS. CODE	ORIGINAL CODE	DESCRIPTION	unit price	10 pack price
1	152001W	10048529 HK08	BYSTRONIC® NOZZLE Ø 0.8		
	152002W	10035266 HK10	BYSTRONIC® NOZZLE Ø 1.0		
	152003W	10035267 HK12	BYSTRONIC® NOZZLE Ø 1.2		
	152004W	10035268 HK15	BYSTRONIC® NOZZLE Ø 1.5		
	152005W	10035269 HK17	BYSTRONIC® NOZZLE Ø 1.75		
	152006W	10035270 HK20	BYSTRONIC® NOZZLE Ø 2.0		
	152007W	10035271, HK25	BYSTRONIC® NOZZLE Ø 2.5		
	152008W	10035272 HK30	BYSTRONIC® NOZZLE Ø 3.0		
	152009W	10049744 HK35	BYSTRONIC® NOZZLE Ø 3.5		
2	152015W	10049747 NK10-15	BYSTRONIC® DOUBLE NOZZLE Ø 1.0		
	152016W	10035275 NK12-15	BYSTRONIC® DOUBLE NOZZLE Ø 1.2		
	152017W	10035278 NK15-15	BYSTRONIC® DOUBLE NOZZLE Ø 1.5		
	152018W	10035290 NK17-15	BYSTRONIC® DOUBLE NOZZLE Ø 1.75		
	152019W	10035292 NK20-15	BYSTRONIC® DOUBLE NOZZLE Ø 2.0		
	152020W	10035294 NK25-15	BYSTRONIC® DOUBLE NOZZLE Ø 2.5		
	152021W	10035296 NK25-20	BYSTRONIC® DOUBLE NOZZLE Ø 2.5		
	152022W	10035298 NK30-17	BYSTRONIC® DOUBLE NOZZLE Ø 3.5		
	152023W	10035301 NK30-20	BYSTRONIC® DOUBLE NOZZLE Ø 3.0		
	152024W	10035303 NK35-30	BYSTRONIC® DOUBLE NOZZLE Ø 3.5		
	152025W	10068496 NK35-17	BYSTRONIC® DOUBLE NOZZLE Ø 3.5		
	152026W	10068496 NK40-17	BYSTRONIC® DOUBLE NOZZLE Ø 4.0		

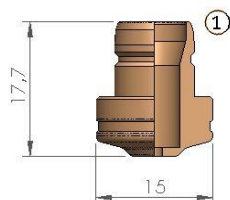

POS	LS. CODE	ORIGINAL CODE	DESCRIPTION	unit price	10 pack price
1	152030W	10039202	BYSTRONIC® NOZZLE Ø 2.0		

San Giorgio Plasma Parts srls is not affiliated with the named manufacturers. Reference to machines, parts, descriptions, and model numbers are for convenience in verifying compatibility only. All parts are made by or for San Giorgio Plasma Parts srls and are not made by the reference manufactures (unless expressly indicated). All other trademarks are the properties of their respective owners."

## Replacement parts suitable for BYSTRONIC®



POS	LS. CODE	ORIGINAL CODE	DESCRIPTION	unit price	10 pack price
1	152032CKW	10084700	BYSTRONIC® NOZZLE Ø2.0 F20 DW		
	152033CKW	10084701	BYSTRONIC® NOZZLE Ø2.5 F25 DW		
	152034CKW	10066333	BYSTRONIC® NOZZLE Ø3.0 F30 DW		
	152035CKW	10066332, 10090091	BYSTRONIC® NOZZLE Ø3.5 F35 DW		
2	152036CKW	10068494, 10090092	BYSTRONIC® NOZZLE Ø5.0 F50 DW		
	152037CKW	10066331	BYSTRONIC® NOZZLE Ø4.0 F40 DW		
	152038CKW	10066330	BYSTRONIC® NOZZLE Ø4.5 F45 DW		
	152039CKW	10086053	BYSTRONIC® NOZZLE Ø5.5 F55 DW		
	152040CKW	10086069	BYSTRONIC® NOZZLE Ø6.0 F60 DW		



POS	LS. CODE	ORIGINAL CODE	DESCRIPTION	unit price	10 pack price
1	153001CKW	10089806	BYSTRONIC® NOZZLE Ø2.0 F20		
	153002CKW	10089805	BYSTRONIC® NOZZLE Ø2.5 F25		
	153003CKW	10089803	BYSTRONIC® NOZZLE Ø3.0 F30		
	153004CKW	10090089	BYSTRONIC® NOZZLE Ø3.5 F35		
2	153005CKW	10089802	BYSTRONIC® NOZZLE Ø4.0 F40		
	153006CKW	10089800	BYSTRONIC® NOZZLE Ø4.5 F45		
	153007CKW	10090090	BYSTRONIC® NOZZLE Ø5.0 F50		
	153008CKW	10089799	BYSTRONIC® NOZZLE Ø5.5 F55		
	153009CKW	10089798	BYSTRONIC® NOZZLE Ø6.0 F60		

San Giorgio Plasma Parts srls is not affiliated with the named manufacturers. Reference to machines, parts, descriptions, and model numbers are for convenience in verifying compatibility only. All parts are made by or for San Giorgio Plasma Parts srls and are not made by the reference manufactures (unless expressly indicated). All other trademarks are the properties of their respective owners."

## Replacement parts suitable for BYSTRONIC®

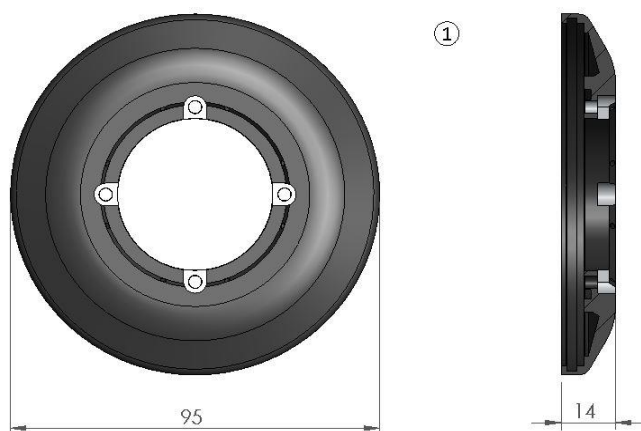

POS	LS. CODE	ORIGINAL CODE	DESCRIPTION	unit price	10 pack price
1	159050	2-03243 Kunde 24608	BYSTRONIC® FRONT PLATE		

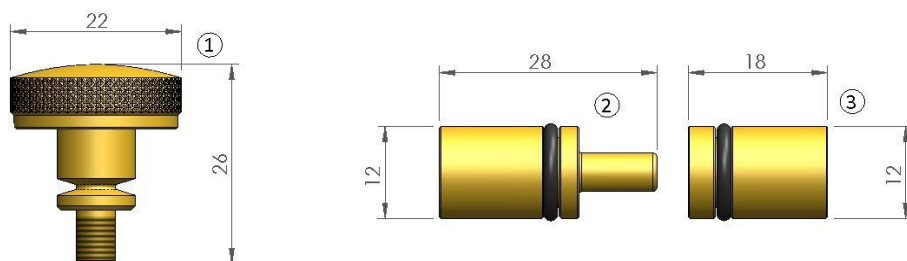

POS	LS. CODE	ORIGINAL CODE	DESCRIPTION	unit price	10 pack price
1	159031	4-04976	BYSTRONIC® KNURLED SCREW		
2	159045	7023207	BYSTRONIC® MALE WATER CONNECTOR		
3	159046	7023208	BYSTRONIC® FEMALE WATER CONNECTOR		
2+3	159047	7023207, 7023208	BYSTRONIC® WATER CONNECTOR MALE + FEMALE		

San Giorgio Plasma Parts srls is not affiliated with the named manufacturers. Reference to machines, parts, descriptions, and model numbers are for convenience in verifying compatibility only. All parts are made by or for San Giorgio Plasma Parts srls and are not made by the reference manufactures (unless expressly indicated). All other trademarks are the properties of their respective owners."